

Piston Pumps

RC2-Mxl model



Instructions for use

Original version in Italian
Third edition – September 2021

Document code
LM05EN003

All rights reserved. The user is not allowed to reproduce, store in a filing system or transmit in any form or by any means, such as a mechanical, photocopying, recording or other system, any part of this publication without the prior written consent of Ragazzini S.r.l. Short excerpts appearing in articles in specialised publications are exempt from the above prohibitions.

ragazzini **rotho** and **rotho·Noxys** are trademarks registered by Ragazzini S.r.l.

The logos  and  are owned by Ragazzini S.r.l.

TABLE OF CONTENTS

A	CHARACTERISTIC DATA – MACHINE CONFIGURATION	(attached to the machine)	
B	GENERAL WARNINGS		5
B.1	RESPONSIBILITY		6
B.2	ORIGINAL VERSION OF THE INSTRUCTIONS		6
B.3	CONFORMITY OF THE PRODUCT		6
B.3.1	COPY OF THE EC DECLARATION OF CONFORMITY		7
B.3.2	IDENTIFICATION PLATE		8
B.4	EXPLANATION OF THE SYMBOLS AND PICTOGRAMS USED IN THE MANUAL		9
B.4.1	WARNING NOTES		9
B.4.2	HAZARD PICTOGRAMS THAT MAY BE PRESENT IN THE INSTRUCTIONS FOR USE		9
C	SAFE INTERACTION WITH THE MACHINERY		10
C.1	WORK ENVIRONMENT		10
C.2	MAN-MACHINE INTERFACES		10
C.3	INTENDED USE OF THE NON-ATEX VERSION PUMP		10
C.3.1	INTENDED USE OF THE MACHINE		10
C.3.2	PROHIBITED USE		10
C.3.3	REASONABLY FORESEEABLE MISUSE OF THE MACHINE		10
C.4	INTENDED USE OF THE ATEX VERSION PUMP		11
C.4.1	INTENDED USE OF THE MACHINE		11
C.4.2	PROHIBITED USE		11
C.5	GUARDS AND SAFETY DEVICES		12
C.5.1	ELECTRICAL SAFETY DEVICES (STANDARD CONFIGURATION WITH ELECTRICAL PANEL)		12
C.5.2	SAFETY FUNCTIONS ACCORDING TO THE EN13849-1 STANDARD		12
C.5.3	MEASURES TO REDUCE NOISE RISKS		12
C.5.4	MEASURES TO REDUCE EXTREME TEMPERATURES RISKS		12
C.5.5	MEASURES TO REDUCE OTHER RISKS		12
C.6	RESIDUAL RISKS		13
C.6.1	RESIDUAL RISKS DURING NORMAL USE OF THE MACHINE		13
C.6.2	RISKS GENERATED BY TAMPERING AND/OR PROHIBITED BEHAVIOUR		13
C.6.3	RESIDUAL RISKS DURING MAINTENANCE		13
C.6.4	DANGEROUS AREAS		13
C.6.5	RISKS FOR EXPOSED PERSONS		14
C.6.6	INFORMATION AND WARNINGS APPLIED ON THE MACHINE		14
C.7	PROTECTIVE MEASURES TO BE TAKEN BY THE USER		15
C.7.1	PERSONAL PROTECTIVE EQUIPMENT		15
D	GENERAL DESCRIPTION		16
D.1	PISTON PUMP UNIT		16
D.2	THEORY OF OPERATION		16
D.3	DIMENSIONS AND VOLUME		17
E	TRANSPORTATION - HOISTING - STORAGE		18
E.1	GENERAL WARNINGS		18
E.2	PERSONAL PROTECTIVE EQUIPMENT		18
E.3	TRANSPORTATION		19
E.4	HOISTING		19
E.5	POSITIONING AND FIXING THE MACHINE		19
E.5.1	POSITIONING OF THE PUMP, VERSION WITH WHEELS		19
E.5.2	POSITIONING AND FIXING OF THE PUMP, VERSION WITH FIXED FRAME (OPTIONAL)		19
E.6	STORAGE		19
F	INSTALLATION		20
F.1	GENERAL WARNINGS		20
F.2	PERSONAL PROTECTIVE EQUIPMENT		20
F.3	OPERATION AND MAINTENANCE AREAS		20
F.4	CHECKS BEFORE INSTALLATION		21
F.5	ELECTRICAL CONNECTION		21
F.5.1	STANDARD CONFIGURATION WITH ELECTRICAL PANEL		21
F.5.2	CONFIGURATION WITHOUT ELECTRICAL PANEL (OPTIONAL)		21
F.6	CONNECTION WITH PRODUCT RECEIVING SYSTEM		22
F.7	PIPES - CORRECT INSTALLATION		23
F.7.1	FLUID PRODUCTS		23
F.7.2	VISCOUS PRODUCTS		23
F.7.3	OVERPRESSURE		23
F.7.4	PUMP STOPPED		23
G	INSTRUCTIONS FOR COMMISSIONING - OPERATION - SHUT-DOWN		24
G.1	GENERAL WARNINGS FOR NORMAL OPERATION OF THE MACHINE		24
G.1.1	CHECKS AND INSPECTIONS FOR THE SAFE USE OF THE MACHINE		24
G.2	PERSONAL PROTECTIVE EQUIPMENT		25
G.3	EMERGENCY STOP		25
G.3.1	RESET AFTER AN EMERGENCY STOP		25
G.4	START		26
G.5	OPERATION		26
G.5.1	ACTIONS TO BE AVOIDED		26
G.6	STOPPING		26
G.6.1	STOPPING THE PUMP		26
G.6.2	DRAINING THE PUMP		26
G.6.3	CLEANING THE PIPES		27

G.6.4	<i>PROLONGED STOPS</i>	27
G.7	COMPLIANCE WITH HYGIENE REQUIREMENTS	27
G.7.1	<i>DRAINAGE</i>	27
G.7.2	<i>CLEANING</i>	27
G.8	RESIDUAL RISKS	27
G.8.1	<i>USE WITH FOOD</i>	27
G.8.2	<i>PUMPING OF DANGEROUS FLUIDS</i>	27
H	TROUBLESHOOTING	28
I	MAINTENANCE	30
I.1	GENERAL WARNINGS	30
I.2	PRECAUTIONS AND WARNINGS WHEN PREPARING THE MACHINE FOR ROUTINE MAINTENANCE	30
I.3	PERSONAL PROTECTIVE EQUIPMENT	31
I.4	PROCEDURES FOR PLACING THE MACHINE IN MAINTENANCE STATUS	31
I.5	NORMAL WEAR PARTS	32
I.5.1	<i>CHECK AND REPLACE THE VALVES</i>	32
I.5.2	<i>CHECK AND REPLACE THE CAPS</i>	32
I.5.3	<i>CHECK AND REPLACE THE ROD SEAL RINGS (GLAND)</i>	33
I.5.4	<i>ROD INSPECTION AND REPLACEMENT</i>	33
I.6	REPLACEMENT/ADJUSTMENT OF THE BELTS	34
I.7	MOTOR / GEARBOX.....	35
I.7.1	<i>MOTOR</i>	35
I.7.1	<i>ATEX VERSION</i>	35
I.7.2	<i>GEARBOX</i>	35
I.8	COMPONENTS MAINTENANCE – PUMP ATEX VERSION	36
J	SPARE PARTS	37
J.1	HOW TO ORDER SPARE PARTS.....	37
J.2	SPARE PARTS ORDER EXAMPLE.....	37
J.3	SPARE PARTS LIST	38
J.4	SEALS.....	39
J.4.1	<i>CAPS</i>	39
J.4.2	<i>VALVES</i>	39
J.4.3	<i>RINGS</i>	40
J.4.4	<i>SUMMARY TABLE</i>	41
K	DEMOLITION AND DISPOSAL	42
K.1	GENERAL WARNINGS CONCERNING DEMOLITION AND DISPOSAL OF THE MACHINE	42
K.1.1	<i>SPECIAL AND HAZARDOUS WASTE</i>	42
K.2	PERSONAL PROTECTIVE EQUIPMENT REQUIRED DURING MACHINE DEMOLITION AND DISPOSAL.....	42
K.3	MACHINE DISMANTLING.....	42
K.4	SORTING THE MATERIALS	43
K.5	DISPOSING OF MACHINE MATERIALS AND PRODUCTS.....	43
L	PUMP OPTIONAL CONFIGURATIONS	44
L.1	OPTIONAL MOTOR VERSIONS.....	44
L.1.1	<i>ATEX VERSION</i>	44
L.2	PRESSURE SWITCH	45
L.2.1	<i>TECHNICAL DATA</i>	45
L.2.2	<i>ELECTRICAL CONNECTIONS</i>	45
L.2.3	<i>CALIBRATION</i>	45
L.2.4	<i>OVERALL DIMENSIONS</i>	45
L.2.5	<i>ATEX VERSION</i>	45
M	IDEAL CHARACTERISTIC PERFORMANCE OF THE PISTON PUMP	46

B GENERAL WARNINGS

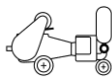
- Carefully read the manual before starting any operation.
- The machine must be used as supplied by Ragazzini S.r.l., following all the instructions and indications given in this manual.
- The necessary spare parts for each component will be supplied by Ragazzini S.r.l.; otherwise we decline any kind of responsibility for the product and/or for the damage it may cause.
- These instructions contain useful information for training and informing the operator, in order to avoid improper and dangerous use of the machine.
- The instructions must be integrated by the legislative provisions and technical standards in force; they do not replace any system regulations and any additional prescriptions, even non-legislative, which have been issued in any case for safety purposes.
- The instructions for use are an integral part of the machine; it is necessary to keep them in good condition, in a safe place and available to the operator (or anyone who requests them, as long as this person is authorised to use the machine) for the entire productive life of the machine.
- In the case of sale, rental, use or financial leasing of the machine, the instructions must be attached to the machine.
- Check for updates to this document on the site <http://www.ragazzini.it/pompa-a-pistoni/download/>
- The employer (or their representative) must have the operators read the contents of these instructions.
- Unfamiliarity with the information and warnings given in this manual can lead to situations of risk for the health and safety of operators.
- The operator must comply with the warnings and procedures set down in these instructions in all stages of the machine's life cycle.
- Piston pumps are machines that have dangerous parts, as they are live and equipped with moving parts. Therefore:
 - Any improper use
 - The removal of the protections and/or the disconnection of the protection devices
 - The lack of inspections and maintenanceCan cause serious damage to people or things.
- If the operator detects discrepancies between what is described in this document and the machine, they must immediately inform their supervisor¹ without using the machine: incorrect or rash manoeuvres can be a source of danger to the health of the operator and/or the people who are near the machine.
- The safety manager must ensure that the machine is handled, installed, commissioned, used, serviced and repaired exclusively by qualified personnel who must therefore have:
 - Specific technical training and experience.
 - Knowledge of technical standards and applicable laws.
 - Knowledge of the general national, local and plant safety requirements.
- The machine is intended to be part of an industrial plant. It is the customer's responsibility (through their Health and Safety Manager) to guarantee overall safety and carry out the analysis of the risks associated with the interfacing with other plant components.
- Adopt the necessary additional protection measures and related signs.
- The following works cannot be carried out without the authorisation of the Health and Safety Manager:
 - Installation
 - System modifications (configuration or intended use)
 - Interventions on the electrical parts of the machine.

¹ Supervisor: they represent the operational function, the person who has a good knowledge of the workplace and its occupants, who supervises the work activities and ensures that the instructions given are observed. They have duties of surveillance and supervision of the instructions given.

B.1 RESPONSIBILITY

The manufacturer Ragazzini S.r.l. is not responsible for:

- Improper use of the machine or its use for purposes other than those envisaged;
- Failure to comply with the instructions for use and maintenance provided by Ragazzini S.r.l.;
- Failure to comply with the regulations and safety measures contained in this manual and/or in the supplementary documentation provided;
- Any tampering, replacement or modification (not authorised in writing by the manufacturer Ragazzini S.r.l.) of one or more parts of the machine;
- Any intervention that is not part of ordinary maintenance.

Therefore, Ragazzini S.r.l. is not responsible for any direct or indirect damage deriving from failure to comply with the above mentioned indications.

B.2 ORIGINAL VERSION OF THE INSTRUCTIONS

This document was originally issued in Italian.

In the event of disputes due to translated versions, even if provided by Ragazzini S.r.l., the only valid text shall remain solely and exclusively the original Italian version.

B.3 CONFORMITY OF THE PRODUCT

The machine described in these instructions was designed and built to be installed in a plant with industrial characteristics.

The machine is marketed:

- With EC declaration of conformity pursuant to directive 2006/42/EC, annex II, point 1 A.
- With EC declaration of conformity pursuant to directive 2014/34/EU, annex X, letter b (ATEX version).

Any modification that alters the design and construction characteristics of the machine in terms of the place of use and of safety and risk prevention, may only be carried out by the manufacturer, who will subsequently certify its compliance with the safety standards in force.

Any changes in location, modifications or maintenance operations not contemplated in this document are to be considered unauthorised.

Under no circumstance will Ragazzini S.r.l. be held responsible in case of non-compliance with the above safety dispositions.

B.3.2 Identification plate

The machine is identified by the type, serial number and year of construction marked on the identification plate applied on the machine.

The following warnings must to be respected at all times:

- Never remove the identification plate from the original position chosen by the machine manufacturer;
- Do not alter or falsify the technical information on the plate;
- Do not clean the plate using abrasive tools (such as steel brushes) to avoid making the information illegible.



PLEASE NOTE: All the data marked on the plate must always be legible. Refer to the identification data in all communications with the manufacturer, e.g. requests for replacement parts, information, and technical assistance. If the plate deteriorates with use and is no longer legible, even in only one of its elements, another one must be requested from the manufacturer, by referring to the data contained in this manual or on the original plate.

B.4 EXPLANATION OF THE SYMBOLS AND PICTOGRAMS USED IN THE MANUAL

B.4.1 Warning notes

Warnings relating to possible risks to the health and safety of the operator are highlighted with warning notes accompanied by the relative hazard pictogram (see paragraph B.4.2 “Hazard pictograms that may be present in the instructions for use”); the text of the note is highlighted with a yellow background.

Below is an example of a warning note:

MOVING PARTS HAZARD: It is forbidden to remove or tamper with the guards.	
--	---

The specific instructions / warnings for ATEX pumps are highlighted as follows (the text of the note is highlighted with a yellow background and shows the pictogram relating to environments subject to the risk of explosion and fire).







Note text	
-----------	---

Instructions whose non-fulfillment compromises the correct operation of the machine are highlighted as follows:

Note text	
-----------	---

B.4.2 Hazard pictograms that may be present in the instructions for use

This manual contains the following hazard pictograms:

	DANGER		ELECTROCUTION		MOVING PARTS
	HANGING LOADS		HIGH TEMPERATURE		DANGEROUS SUBSTANCES

C SAFE INTERACTION WITH THE MACHINERY

C.1 WORK ENVIRONMENT

Refer to the customer's production line.

C.2 Man-machine interfaces

Refer to section L "PUMP OPTIONAL CONFIGURATIONS" for further information on the controls to be managed by the operator, if any. For a description of the controls, refer to the attached documentation.

C.3 INTENDED USE OF THE NON-ATEX VERSION PUMP

C.3.1 Intended use of the machine

The piston pump series was designed and built by Ragazzini S.r.l. for pumping fragile, abrasive, corrosive and alimentary fluids compatibly with the materials of which the pump itself is made and wherever the transfer of large masses of liquids is required. Based on the characteristics of the product to be transferred, the machine is equipped with the most suitable seals as indicated in the paragraph J.4 "SEALS".

The machine must only be used on flat surfaces. In the version supplied with wheeled frame, turn the front wheels with respect to the axis of the machine as a braking system.

Environmental limits of the machine:

- Ambient temperature: $> 0^{\circ}\text{C}$ and $\leq 40^{\circ}\text{C}$. For ambient temperatures $\geq -20^{\circ}\text{C}$ and $\leq 0^{\circ}\text{C}$, contact Ragazzini Technical Service.
- Work environment: indoor or outdoor with protection from sunlight and bad weather.
- Lighting: The area of installation must be sufficiently lit (minimum 200 lux).

ANY OTHER USE DIFFERENT FROM THE ONE DESCRIBED IS NOT ALLOWED BY THE MANUFACTURER.

C.3.2 Prohibited use.

The equipment must not be used:

- To process flammable materials.
- Without liquid to be pumped (dry running) for more than 10 minutes.
- For operations other than those described under paragraph C.3.1 "Intended use of the machine".
- In open environments or in closed places without a lightning protection system.
- With direct exposition to sunlight.

Restrictions on the use of the machine:

It is forbidden to:

- Use the machine in a configuration other than the one envisaged by the manufacturer.
- Use the machine in places subject to the risk of explosion and/or fire (the machine is not certified according to the 2014/34/EU ATEX directive).
- Use the machine with fluids at a temperature higher than the one allowed by the machine components. (See paragraph J.4 "SEALS")
- Integrate other systems and/or equipment not foreseen by the manufacturer in the design.
- Remove components and parts of the machine.
- Perform interventions when the machine is stopped but before disconnecting the electrical power supply. The machine could receive a remote ("auto") consent signal and could restart suddenly.
- Move the machine, when connected to the electric power supply.

C.3.3 Reasonably foreseeable misuse of the machine

It is forbidden to:

- Tamper with the machine or its safety devices;
- Tamper with fixed and removable guards;
- By-pass the safety devices;
- Climb onto and/or walk on the machine.

C.4 INTENDED USE OF THE ATEX VERSION PUMP

C.4.1 Intended use of the machine

The piston pump series was designed and built by Ragazzini S.r.l. for pumping fragile, abrasive, corrosive and alimentary fluids compatibly with the materials of which the pump itself is made and wherever the transfer of large masses of liquids is required. Based on the characteristics of the product to be transferred, the machine is equipped with the most suitable seals as indicated in the paragraph J.4 "SEALS".

The machine must only be used on flat surfaces. In the version supplied with wheeled frame, turn the front wheels with respect to the axis of the machine as a braking system.



To ensure the correct use of the pump, always check:

- The presence of lubricant, where necessary (crankcase, variator, etc.).
- That the pumped fluid is always compatible with the construction materials of the pump itself.
- That in the processed fluid there are not and there may not be solid parts or foreign bodies of large dimensions or such as to cause damage or compromise safety.
- That there is no oxidized steel nor ferromagnetic parts, even small ones.
- That there are no conditions that could cause motor overload.
- The correct grounding of the pump, the motor or other components connected to it.

Environmental limits of the machine:

- Ambient temperature: $> 0^{\circ}\text{C}$ and $\leq 40^{\circ}\text{C}$. For ambient temperatures $\geq -20^{\circ}\text{C}$ and $\leq 0^{\circ}\text{C}$, contact Ragazzini Technical Service.
- Work environment: indoor or outdoor with protection from sunlight and bad weather, classified as ATEX zone II 2G h IIB T4 Gb - II 2D h IIIB T = 135°C Db .
- Lighting: The area of installation must be sufficiently lit (minimum 200 lux).

ANY OTHER USE DIFFERENT FROM THE ONE DESCRIBED IS NOT ALLOWED BY THE MANUFACTURER.

C.4.2 Prohibited use.

The equipment must not be used:

- For operations other than those described under paragraph C.4.1 "Intended use of the machine".
- In places with temperatures outside the range between -20°C and $+40^{\circ}\text{C}$.
- Near systems generating stray electrical currents.
- In open environments or in closed places without a lightning protection system.
- With direct exposition to sunlight.
- Without liquid to be pumped (dry running) for more than 10 minutes.

Restrictions on the use of the equipment:

It is forbidden to:

- Use the equipment in a configuration other than the one envisaged by the manufacturer.
- Use the equipment in areas classified as Zone 0-20.
- Use the equipment in areas containing gases whose flammability temperature is below 135°C .
- Use the machine in areas subject to the presence of IIC classified gases.
- Pump products with a temperature above 40°C ; exceeding this limit does not allow compliance with the temperature class.
- Integrate other systems and/or equipment not foreseen by the manufacturer in the design.
- Remove components and parts of the machine.
- Use the pump in case of product/pumped fluid leaks.

C.5 GUARDS AND SAFETY DEVICES

The machine is equipped with safety devices to prevent damage to the operator and to the machine itself. The machine is equipped with a fixed guard preventing access to dangerous components, such guard being fixed by means of fastening devices that require the use of tools.

The other moving parts (electric motor) are commercial components already certified by their manufacturers.

MOVING PARTS HAZARD: It is forbidden to remove or tamper with the guards.	
--	---

C.5.1 Electrical safety devices (standard configuration with electrical panel)

The machine is equipped with an electrical panel where all the control devices are installed. The components purchased as part of the electrical equipment are identified, CE-marked and accompanied by the relevant EC Declarations of Conformity. The machine is equipped with a red emergency stop push-button on a yellow backplate, positioned on the electrical panel.

ELECTROCUTION HAZARD: In case of fire in the vicinity of the machine (or on the machine itself), the use of water or other aqueous/humid extinguishing agents is prohibited, as this presents a risk of electrocution due to indirect contact.	
---	---

C.5.2 Safety functions according to the EN13849-1 standard

The safety functions implemented on the machine² are listed below:

Name of the safety function	PL ³
Stopping of the pump upon pressing the emergency button	c
ATEX version and on request: stopping of the pump upon pressure switch intervention	c

For the technical characteristics of the pressure switch, see paragraph L.2 “PRESSURE SWITCH”.

C.5.3 Measures to reduce noise risks

The value shown below refers to the measurements made on a pump produced by Ragazzini S.r.l., technically comparable and representative of the machine described in these instructions.

All the other machines produced by Ragazzini S.r.l. have a noise level lower than the one reported.

Type	6NCM
Series no.	16155252
A-weighted sound pressure level in the workplace	78.6 dB (A)

C.5.4 Measures to reduce extreme temperatures risks

HIGH TEMPERATURE HAZARD: in case of pumping fluids with a constant temperature higher than 60°C it is necessary to provide suitable signs or shielding.	
--	---

C.5.5 Measures to reduce other risks

HAZARD: The machine is not equipped with lightning protection; it must be installed in places protected against this risk.	
---	---

² The definition of safety function is given in the UNI EN ISO 13849-1 standard; a safety function is a function of the machine whose failure can lead to an immediate increase in the risk related to the machine itself.

³ PL (Performance Level): in the UNI EN ISO 13849-1 standard the *Performance Level* is defined as a discrete level used to specify the ability of safety-related control parts to perform a safety function under the intended conditions. 5 values are assigned to the Performance Level, from PL_a to PL_e as the risk increases (PL=e > PL=d > PL=c > PL=b > PL=a).

C.6 Residual risks

Risks deriving from:

- Inattention of the operator,
- Failure to comply with the information and warnings contained in this manual,
- Unauthorised uses of the machine;

Cannot be totally eliminated by a inherently safe design, due to the machine construction type.

Information on the residual risks existing despite adopting the protection measures described in this manual are described below.

WARNING: All handling, installation, maintenance and dismantling operations must be carried out in the absence of an explosive atmosphere. 

C.6.1 Residual risks during normal use of the machine

During the normal operation of the machine there are no dangers for the operator if the guards and protections are intact and correctly installed, as the movements that entail a hazard condition are enclosed within the guards.

C.6.2 Risks generated by tampering and/or prohibited behaviour

In the event of tampering and/or incorrect assembly of the protection devices (belt covers) both with the machine running and with the machine stopped, the following residual risks are generated, related to mechanical hazards:

List of hazards		Identification of the dangerous situation			Detailed description of the risk
Type or group	Origin	Potential consequences	Dangerous area	Phase of the life cycle	
Mechanical	High pressure	Projection of objects Friction/abrasion	Machine area	Production Maintenance Adjustment	Risk of damage due to the projection of objects or fluids under pressure during operation or when the machine is stopped due to residual pressures in the pipes or parts of blocked pipes.
Mechanical	Rotating parts	Dragging or entrapment Crushing Shearing	Machine area	Production Maintenance Adjustment	Risk of contact between moving parts of the machine (drive components, belts, electric motor, gearbox) and parts of the operator's body

Another source of risk for the operator caused by prohibited behaviour can arise due to failure to use adequate PPE (Personal Protective Equipment)

C.6.3 Residual risks during maintenance

During machine maintenance, the possibility of injury is reasonably foreseeable:

- To the upper limbs (abrasion against mechanical parts),
- To the lower limbs (fall of mechanical parts if not adequately supported),
- To the eyes (dangers generated by pressurised fluids and live elements),
- To the head (contact with machine parts).

If the emergency stop button is pressed, only the power cables remain energised.

C.6.4 Dangerous areas

Based on the above considerations, the following are to be considered dangerous areas:

- The area inside the machine, during execution of the production cycle with guards tampered with or removed;
- The area adjacent to the electrical panels with the door open and voltage switched on, during troubleshooting interventions.

C.6.5 Risks for exposed persons

Exposed persons are people not involved in the operation of the machine, therefore other people working in the company or visitors.

These instructions do not deal with problems external to the company using the machine: in this sense, a person standing in an area close to the company premises is not considered an exposed person.

In this type of machine there are no risks for exposed persons during operation (with the door of the electrical panel closed and the machine in its full safety condition).

<p>WARNING: NO ACCESS TO UNAUTHORIZED PERSONNEL</p> <p>During normal operation, keep exposed persons at a safe distance from dangerous areas.</p> <p>During maintenance: it is absolutely forbidden to let people go near the machine. It is recommended to fence off the entire external perimeter area of the machine, also displaying, if necessary, the sign "MACHINE UNDER MAINTENANCE".</p>	
--	---

C.6.6 Information and warnings applied on the machine

Following the identification of some residual risks, some warning signs have been installed on the machine, which have been defined in accordance with the European and international standards relating to graphical hazard symbols to be used on systems (EN ISO 7010).

The Customer must immediately replace any warning plate that, as a result of wear, has become illegible.

The warning plates applied on the machine are the following:

Prohibition to remove guards



Obligation to read the instructions for use







<p>WARNING:</p> <p>It is absolutely forbidden to remove the warning plates applied on the machine.</p> <p>Ragazzini S.r.l. declines all liability as far as the machine safety is concerned in the event of non-compliance with this prohibition.</p>	
---	---

C.7 Protective measures to be taken by the user

C.7.1 Personal Protective Equipment

To safeguard the operator's health in the various stages of the machine's life cycle, it is mandatory to use (or have available) the PPE (Personal Protective Equipment) mentioned below. The manufacturer obliges the Customer to use the machine with PPE compliant with the directive on Personal Protective Equipment duly provided with the CE marking. The operator must comply with the directive that defines the methods of use of personal protective equipment during work. Since it is impractical to predict all possible machine operating conditions, the PPE listed refer only to the use of the machine: the employer must prescribe the use of any additional PPE required in compliance with the actual situation in their production site.

PPE to be used in the various stages of the machine's life cycle			
Pictogram	Description	Stage of the life cycle of the machine	Note
	FOOTWEAR	<ul style="list-style-type: none"> • transportation; • installation; • use; • maintenance; • dismantling and demolition 	Use of safety shoes to avoid the risks generated by falling materials.
	DIELECTRIC FOOTWEAR WITHOUT METALLIC PARTS FOR ELECTRICIANS	<ul style="list-style-type: none"> • maintenance on electrical parts 	Use of insulating footwear to prevent the dangers that can be generated by direct or indirect contacts.
	PROTECTIVE GLOVES	<ul style="list-style-type: none"> • transportation; • installation; • maintenance; • dismantling and demolition 	Gloves for hand protection available in case of manipulation of objects that can cause damage or injuries.
	INSULATING PROTECTIVE GLOVES	<ul style="list-style-type: none"> • maintenance on electrical parts 	Use of insulating protective gloves to prevent the dangers that can be generated by direct or indirect contacts
	HELMET	<ul style="list-style-type: none"> • transportation; • installation; • use; • maintenance; • dismantling and demolition 	Protective helmet to be used during machine hoisting operations to prevent the dangers generated by hanging loads.
	SUITABLE CLOTHING	<ul style="list-style-type: none"> • transportation; • installation; • use; • maintenance; • dismantling and demolition 	Suitable clothing, such as overalls: it is prohibited to wear wide sleeves and/or loosen clothing that could be easily caught in mechanical parts.
	FACE SHIELD	<ul style="list-style-type: none"> • maintenance 	Face protective shield during work on parts of the system and on electrical parts, especially if live.

WARNING: The machine does not exceed the noise level established by law; therefore hearing protection earmuffs are not mandatory. However, the operator must also carefully evaluate the environment of use: if it is very noisy, protective earmuffs must be used. When using protective earmuffs, the operator must pay even more attention, as one of the senses of perception of danger (hearing) is missing. Observe the surrounding environment well, as the visual perception must compensate for the lacking sense of hearing.



D GENERAL DESCRIPTION

D.1 PISTON PUMP UNIT

The piston pump can consist of the following elements (picture is indicative only):

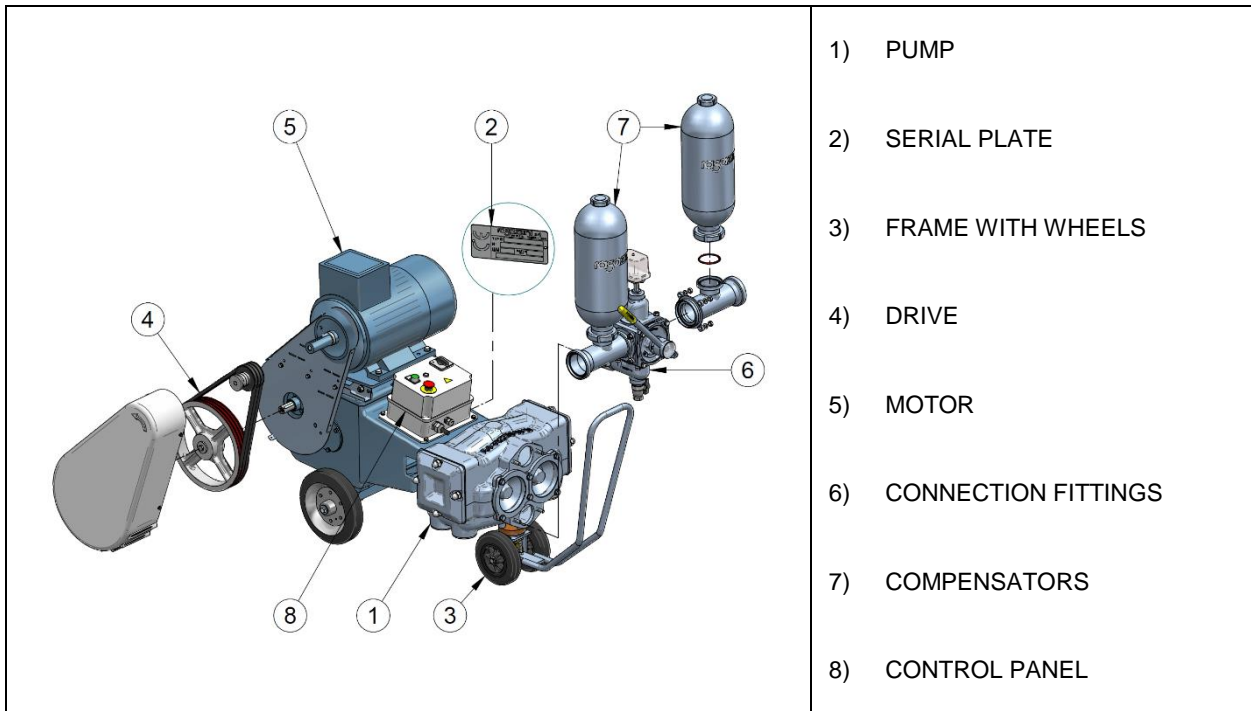

D.2 THEORY OF OPERATION

- The pumps described in this manual are volumetric pumps with double-acting cylinders and free ball valves.
- The reciprocating movement of the pistons is obtained through a “sector system” which guarantees a linear flow (minimum accelerations) and with a double guide that supports the piston in the cylinder.
- The predisposition for the installation of compensation tanks directly on the delivery and suction pipes ensures their stability.
- The flow rate is proportional to the number of revolutions.
- Dry running (empty pump) for max. 10 minutes does not cause any damage.
- A four-way valve allows reversing the flow in the delivery and suction pipes.

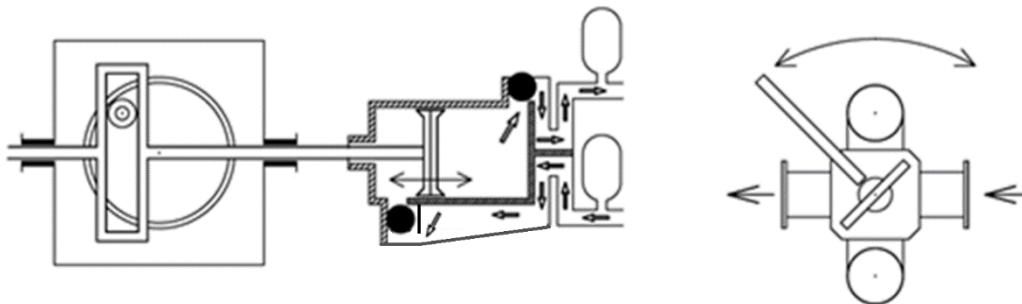

D.3 DIMENSIONS AND VOLUME

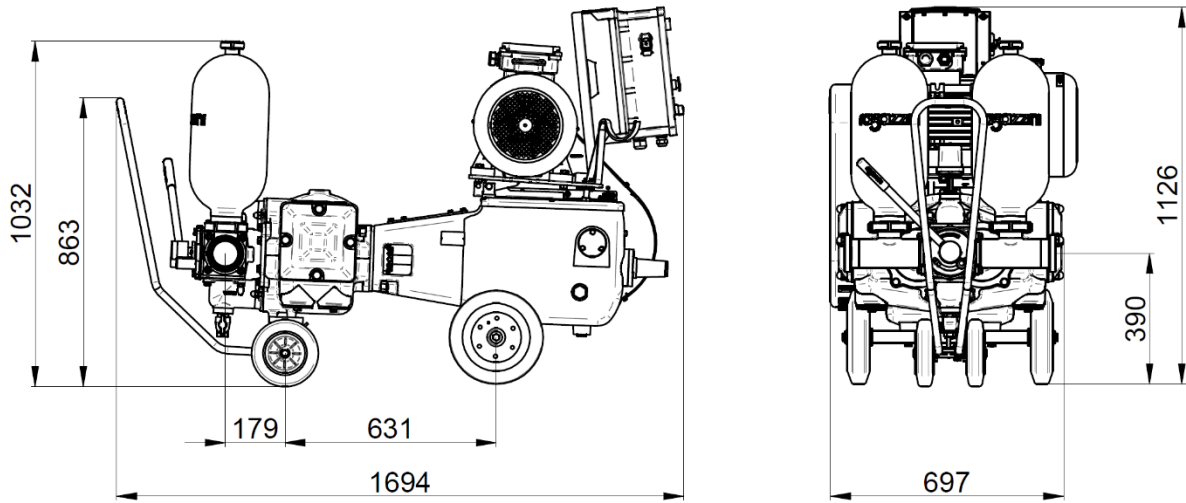

The above images are indicative only; for more details or references to dimensions for specific configurations contact the Technical Service of Ragazzini S.r.l.

E TRANSPORTATION - HOISTING - STORAGE

E.1 GENERAL WARNINGS

The operator responsible for transporting, hoisting and storing the machine must:

- Be a person adequately trained and informed about the work they are about to do;
- Use the personal protective equipment listed in the following paragraph (see paragraph E.2);
- Use suitable equipment to carry out the operations safely and check that such equipment is in perfect condition;
- Use all service equipment as intended by their respective manufacturers.

Before handling the machine, it is necessary to check the capacity and efficiency of the lifting means:

<p>HAZARD: To hoist the machine or some parts of it, it is necessary to use means with a minimum capacity greater than the declared weight of the machine (about 650 kg).</p>	
--	---

Carry out hoisting and transport operations bearing in mind the following warnings:





<p>HANGING LOAD HAZARD During the hoisting operations make sure that there are no exposed persons in the area occupied by the machine and in the surrounding areas. Hoisting must be carried out seamlessly (free from abrupt movements). During the hoisting procedures, the machine must always be in a stable and secure position. For better load stability, keep the load as low as possible when moving the machine.</p>	
---	---

<p>During hoisting, avoid sudden movements that could damage to the machine.</p>	
--	---

<p>WARNING: All handling operations must be carried out in the absence of an explosive atmosphere.</p>	
---	---

E.2 PERSONAL PROTECTIVE EQUIPMENT

The operator responsible for transporting, hoisting and storing the pump must use the following personal protective equipment:

Pictogram	Description	Note
	FOOTWEAR	Use of safety shoes to avoid the risks generated by falling materials.
	PROTECTIVE GLOVES	Gloves for hand protection available in case of manipulation of objects that can cause damage or injuries.
	HELMET	Protective helmet to be used during machine hoisting operations to prevent the dangers generated by hanging loads.
	SUITABLE CLOTHING	Suitable clothing, such as overalls: it is prohibited to wear wide sleeves and/or loosen clothing that could be easily caught in mechanical parts.

E.3 TRANSPORTATION

The pump must be handled by means of a suitable mechanical hoisting device.
The pump is protected by a packaging consisting of a rigid bottom (pallet) and a cardboard casing.

The materials that make up the packaging are recyclable.



E.4 HOISTING

To hoist the pump, where necessary, use special straps by applying them as shown in the figure (lifting with overhead crane or crane).

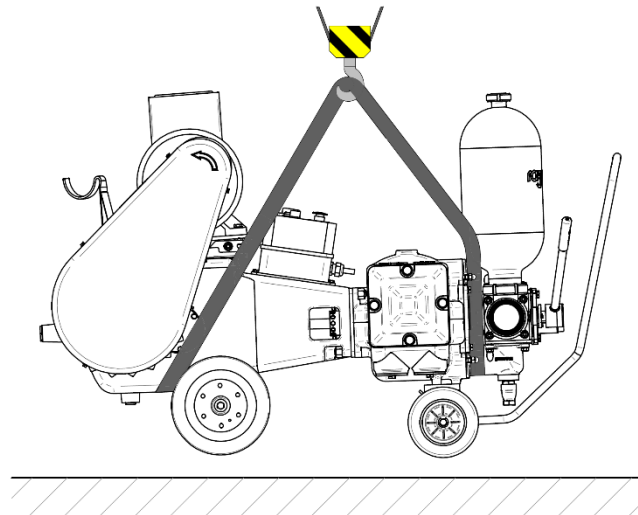

E.5 POSITIONING AND FIXING THE MACHINE

E.5.1 POSITIONING OF THE PUMP, VERSION WITH WHEELS

The pumps supplied with wheeled frame are equipped with steering wheels with handle. To position the pump in the place intended for operation, use the handle and manually pull or push the pump.

<p>HAZARD: It is forbidden to connect the pump to other machinery in order to move the pump.</p>	
---	--

The machine stops by rotating the steering wheels with respect to the fixed wheels.
The rear wheels can be equipped with an optional built-in brake.

E.5.2 POSITIONING AND FIXING OF THE PUMP, VERSION WITH FIXED FRAME (OPTIONAL)

Firmly fix the pump to a fixed structure using the dedicated holes on the frame.
Install the pump on anti-vibration mounts in order to reduce vibrations.

E.6 STORAGE

Do not store the machine outdoor, in areas exposed to bad weather or very humid: place the pump away from direct sunlight and heat sources, contamination, floods and drains. Place the pump in a safe area, outside the hazardous areas , in areas forbidden to unauthorized personnel. It leaves at the discretion of the customer the protection from dust, dirt, animals. For storage periods longer than 60 days, protect any coupling surfaces with suitable antioxidant products.

<p>The ball valves and the spare caps must be stored in a dry environment with no direct light.</p>	
---	--

F INSTALLATION

F.1 GENERAL WARNINGS

The operator responsible for machine installation must:

- Be a person adequately trained and informed about the work they are about to do;
- Use the personal protective equipment listed in paragraph F.2;
- Use suitable equipment to carry out the operations safely and check that such equipment is in perfect condition;
- Use all service equipment as intended by their respective manufacturers.

WARNING: All installation operations must be carried out in the absence of an explosive atmosphere.



F.2 PERSONAL PROTECTIVE EQUIPMENT

The operator responsible for the installation procedure of the pump must use the following personal protective equipment:

Pictogram	Description	Note
	FOOTWEAR	Use of safety shoes to avoid the risks generated by falling materials.
	PROTECTIVE GLOVES	Gloves for hand protection available in case of manipulation of objects that can cause damage or injuries.
	HELMET	Protective helmet to be used during machine hoisting operations to prevent the dangers generated by hanging loads.
	SUITABLE CLOTHING	Suitable clothing, such as overalls: it is prohibited to wear wide sleeves and/or loosen clothing that could be easily caught in mechanical parts.

F.3 OPERATION AND MAINTENANCE AREAS

The area chosen for the installation of the machine must be well lit, ventilated, far from heat sources and such as to guarantee the correct operation of the machine, considering in particular access to the controls and to maintenance activities. The surrounding free space must be 500 ÷ 800 mm.

In case the pump must be installed outdoor, suitable shelters from direct sun and bad weather must be provided.

HAZARD:

The machine is not equipped with lightning protection; therefore, it must be installed in areas protected from this risk.



HAZARD:

The machine must only be used on flat surfaces. Use the handle and turn the front wheels with respect to the axis of the machine as a braking system.



F.4 CHECKS BEFORE INSTALLATION

Once removed from the packaging, check that the machine is free of abrasions or damaged parts.



The materials that make up the packaging are recyclable.

Check that the mains voltage is compliant with the one required by the motor.

Check the diameter of the fittings to be connected to the pump.

HIGH TEMPERATURE HAZARD: If the pumped fluid has a constant temperature above 60°C, the walls of the pump can reach temperatures that are dangerous for direct contact, so it is necessary to provide appropriate signs or shielding.



F.5 ELECTRICAL CONNECTION

F.5.1 STANDARD CONFIGURATION WITH ELECTRICAL PANEL

These operations must be carried out at the end of the machine positioning and fixing operations, in order to guarantee the correct functioning of the machine.

Electrical power supply connection

The connection of the machine to the mains must be carried out by specialised personnel, in compliance with state-of-the-art technical practices and safety standards in force.

The machine must be connected to a protected earth circuit of proven efficiency.

If in doubt about the efficiency of the earth circuit, do not connect the machine.

The User is required to provide an adequate disconnect switch of the electrical line upstream of the machine, as well as effective means of protection against surge currents and indirect contacts.

Effective means of protection against surge currents can be represented by the following elements (correctly sized and adapted to the characteristics of use):

- Fuses,
- Automatic cut-outs,
- Thermal-magnetic circuit breakers.

Effective means of protection against indirect contacts can be:

- Residual current devices,
- Fault sensors.

When connecting the machine to the mains, check:

- That the data of the power supply correspond to the electrical data indicated in the wiring diagram attached to the machine (an incorrect power supply voltage can damage the machine);
- That the power supply network is equipped with an adequate grounding system.

The correct position and fixing of:

- Guards,
- Emergency button.

Connect the electrical panel of the machine using cables which are suitable for the current absorbed.

Use connection accessories (cable lugs, bolts, etc.) suitable for the cable to be connected and for the current absorbed; these devices must be assembled according to the manufacturer's and accessories instructions, as well as according to state-of-the-art technical practices.

Use wiring accessories (sheaths, junction boxes, etc.) that do not compromise the IP protection degree of the electrical panel.

For a description of the controls, refer to the attached documentation.

F.5.2 CONFIGURATION WITHOUT ELECTRICAL PANEL (OPTIONAL)

The electrical panel and manual controls:

- Must be installed at a height and in a position such as to allow easy access without effort for the operator during use.
- They must also be installed outside dangerous areas.

Useful information on this can be found in the standards EN60204-1 and EN894-4.

The electric control panel and the connection cables must comply with the regulations in force.

The electrical panel must be fitted for the control of electrical components.

If the control panel is remote, install a start pushbutton and an emergency stop pushbutton near the pump. No means shall be provided to disable said controls from the electrical panel to be used for maintenance purposes.

<p>HAZARD: the machine, if not supplied in the configuration with electrical panel, must be equipped with an emergency stop button by the customer.</p>	
--	---

Install a power supply disconnecting device into the fixed wiring. This device must be padlockable in open (disconnected) position.

<p>ELECTROCUTION HAZARD: During maintenance work on the pump or for interventions on electrical components, the machine must be stopped and disconnected from the mains.</p>	
---	---

F.6 CONNECTION WITH PRODUCT RECEIVING SYSTEM

SUCTION: the pump must be located as close as possible to the source of the fluid, so as to allow the use of a suction pipe of minimum length and as straight as possible. Avoid sharp turns.

<p>The suction pipe must be perfectly airtight and made of a suitable material, so as not to crush following internal depression. The minimum diameter of the piping must be equal to the nominal diameter of the pump; remember that with viscous fluids it is necessary to use larger diameters.</p>	
--	---

The pump is self-priming so it does not need a foot valve.

DELIVERY: to reduce the absorbed power, use pipes as short and as straight as possible. Avoid sharp turns. The diameter will be equal to the nominal diameter of the pump, except for precise calculations on the pressure drops. With viscous fluids larger diameter tubes are required.

<p>Connect the fixed piping to the pump with a section of flexible hose to facilitate maintenance and avoid loads on the pump. Secure the piping firmly.</p>	
--	---

The pump flow is slightly pulsating and the pulsations increase as the number of revolutions and the pressure increase.

Adapt the brackets to the system to prevent pulsations from causing damage to the pipes or disturbances to downstream services.

F.7 PIPES - CORRECT INSTALLATION

F.7.1 FLUID PRODUCTS

Set up the pump at the minimum distance from the suction tank (inlet).

Arrange the delivery pipe (outlet) at an angle to facilitate the discharge of the pumped fluid

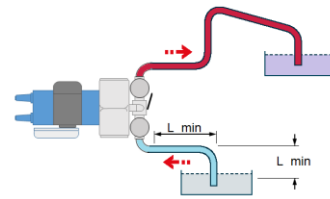

F.7.2 VISCOUS PRODUCTS

Set up the pump in positive suction head condition.

For pumping of corrosive or hazardous substances the pump must be installed in a containment compartment.

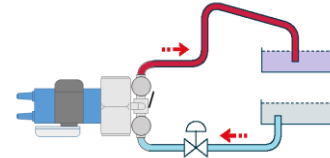

F.7.3 OVERPRESSURE

If the delivery pipeline includes the possibility of a shut-off valve, it is necessary to install a pressure control system or a bypass.

The same hazard may exist on the suction pipe in the event of reverse flow.

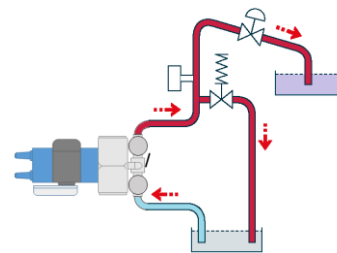

F.7.4 PUMP STOPPED

With positive H, the fluid continues to flow into the pipe: avoid with appropriate valves.

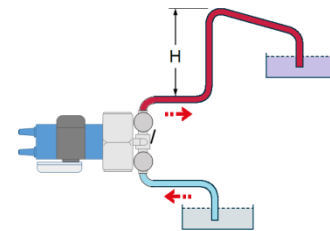

G INSTRUCTIONS FOR COMMISSIONING - OPERATION - SHUT-DOWN

G.1 GENERAL WARNINGS FOR NORMAL OPERATION OF THE MACHINE

The operator must:

- Be trained as required by the laws on safety in the workplace - for Italy see Legislative Decree 81/2008; refer to the laws in force in the Country of the user;
- Be in perfect mental and physical condition, be always alert and with quick reflexes;
- Use personal protective equipment as listed in the following paragraph (G.2);
- Before starting to operate the machine, carry out the checks listed in the following paragraph to ensure that all the safety conditions are met in order to prevent accidents.

The operator must not:

- Tamper with or alter the operation or efficiency of the protection devices installed on the machine.

G.1.1 Checks and inspections for the safe use of the machine

The operator must check:



- That the machine has not been tampered with. If the machine has been altered, it must be put out of service and the supervisor must be notified immediately;
- The general condition of the machine and of its structures: no damage or conditions of evident negligence must be present, especially in relation to ageing, wear and fatigue;
- That the machine bears all the icons and warning plates required, as described in the section “Safe interaction with the machine”;
- That all the control devices are equipped with identification plate.

<p>WARNING: If the machine is damaged or has been modified with respect to its original configuration as established by the manufacturer, it must not be used. Any technical modification affecting the operation or safety of the machine must be carried out exclusively by the manufacturer’s technical personnel or by technicians formally authorised by the manufacturer.</p>	
--	---

<p>WARNING: The preliminary checks must be performed with the machine NOT connected to the electrical supply.</p>	
--	---

G.2 PERSONAL PROTECTIVE EQUIPMENT

The operator responsible for normal operation of the pump must use the following personal protective equipment:

Pictogram	Description	Note
	FOOTWEAR	Use of safety shoes to avoid the risks generated by falling materials.
	PROTECTIVE GLOVES	Gloves for hand protection available in case of manipulation of objects that can cause damage or injuries.
	SUITABLE CLOTHING	Suitable clothing, such as overalls: it is prohibited to wear wide sleeves and/or loosen clothing that could be easily caught in mechanical parts.

<p>WARNING: The machine does not exceed the noise level established by law; therefore hearing protection earmuffs are not mandatory. However, the operator must also carefully evaluate the environment of use: if it is very noisy, protective earmuffs must be used. When using protective earmuffs, the operator must pay even more attention, as one of the senses of perception of danger (hearing) is missing. Observe the surrounding environment well, as the visual perception must compensate for the lacking sense of hearing.</p>	
--	---

G.3 EMERGENCY STOP

If dangerous situations should occur during machine operation:

- For the operator;
- For exposed persons;
- For the machine,

Stop the machine immediately by means of the red emergency stop push-button located on the main control panel.

<p>HAZARD: If the machine is not supplied in the configuration with electrical panel, it is the customer's responsibility to equip it with an emergency stop push-button.</p>	
--	---

G.3.1 Reset after an emergency stop

Once the problem that made the emergency stop necessary has been resolved, proceed as follows:

- Restore the safety conditions needed to restart the machine;
- After checking for the absence of hazardous situations, the authorised operator can resume use of the machine;
- Reset the emergency stop push-button that has been activated by rotating it in the direction indicated by the arrow on the button.

G.4 START

Before starting the pump, make sure that:

- The mains voltage is compatible with the motor voltage and the relevant electrical control panel.

MOVING PARTS HAZARD

- Make sure the guards protecting the moving parts are fitted.
- Check that the oil level in the gearbox is compliant with the required level (see paragraph I.7.2).
- Check that the direction of rotation of the motor is the one indicated on the belt cover: carry out a rotation test.
- Make sure that the motor circuit breaker is calibrated in accordance with the motor rated values.
- Check that the reversing valve is oriented towards the desired supply flow.
- Check that any optional electrical components installed are correctly connected to the panel and test their efficiency.
- If the assessment of the delivery pressure is uncertain, e.g. because of high fluid viscosity, equip the delivery pipeline with a pressure measurement device.



G.5 OPERATION

- Start the pump in optimal condition: valves open and minimum speed, if adjustable.
- Perform some starts and stops, checking the proper operation of the controls and that the system is liquid-tight.
- If the pump can be operated against closed valves, test the related safety devices (pressure switch or bypass).
- Make sure that in correct working conditions the flow rate, pressure and motor power consumption values are in compliance with the design values.



G.5.1 ACTIONS TO BE AVOIDED

WARNING:

- Do not change the use of the pump without carrying out the internal cleaning of the pump: mixing chemical products can be very dangerous.
- When the work process is terminated do not leave the pump full of product, especially in the case of corrosive fluids or fluids that may deposit residues, polymerize or with the risk of frost, or which may strain the mechanics upon the next start.
- In case of insufficient motor power, do not increase the safety device settings beyond the plate limits. Check system data and contact Ragazzini Technical Service if necessary.
- Do not operate the reverse flow valve with the pump running.



HAZARD: When cleaning the pump with water jets, do not direct the jet on the motor or electrical equipment.

Failure to comply with this disposition can generate an electrocution hazard as well as damage to the electrical equipment.



G.6 STOPPING

G.6.1 Stopping the pump

The flow is stopped by stopping the motor. The pump acts as a valve except for the condition provided in F.7.4.

G.6.2 Draining the pump

The pump is drained through the drain plug and by pumping air.
In case of risk of frost, drain the pump at the end of each processing cycle.

G.6.3 Cleaning the pipes

Clean the pipes with fluids compatible with the material of the pump, the valves and the seals.

G.6.4 Prolonged stops

In case of prolonged stops it is necessary to:

- Perform drainage.
- Disconnect the plug or switch off the electricity.
- Loosen the rod sealing “rings”.
- Disassemble and store the valves.
- Position the machine according to the instructions given in the paragraph E.6 STORAGE
- When restarting, start the pump and tighten the “rings” using the gland nut.

G.7 COMPLIANCE WITH HYGIENE REQUIREMENTS

To comply with hygiene requirements (in case of pumping of food fluids) it is necessary to perform the following procedures.

G.7.1 DRAINAGE

To carry out drainage, see the paragraph G.6.2.

G.7.2 CLEANING

The cleaning of the pump must be carried out:

- Before using the pump.
- At the end of each processing cycle.
- At the end of each maintenance activity performed on the pump.

The pump must be cleaned using water at 50°C and 15% caustic soda; carry out rinsing using cold water.

G.8 RESIDUAL RISKS

G.8.1 USE WITH FOOD

<p>WARNING: Compliance with the use of the pump with food fluids is maintained with the use of valves and seals classified for specific use with food, with stainless steel fittings and adequate cleaning procedures (refer to the dispositions in paragraph G.7). Failure to comply with the above indications results in hazards for food type applications.</p>	
--	---

G.8.2 PUMPING OF DANGEROUS FLUIDS

<p>WARNING: If the fluid is dangerous in terms of corrosion or fumes, it is necessary to take adequate precautions, namely:</p> <ul style="list-style-type: none"> • Containment compartments (in case of positive suction head and/or very long delivery pipelines) • Adequate air suction or ventilation (for fluids that may release toxic or harmful fumes) 	
--	---

H TROUBLESHOOTING

PROBLEMS	CAUSES	SOLUTIONS
THE PUMP DOES NOT START OR STOPS	<ul style="list-style-type: none"> • Power grid problem • Emergencies and / or safety devices intervened (see C.5.1 and C.5.2) 	<p>To verify:</p> <ul style="list-style-type: none"> • Presence of voltage • Emergency mushroom (see G.3) • Pressure switch (see L.2) • Motor thermal protection <p>Note: before restoring, make sure that the conditions that caused the intervention have been resolved.</p>
THE PUMP DOES NOT PRIME	The pump has been idle for a prolonged period and the procedure recommended in F6 was not carried out beforehand	Leave pump running. After a short period it will work efficiently again. If the problem occurs when drawing fluid from underground tanks, it is necessary to let the pump draw fluid from an above ground tank
	The suction pipe is crushed or blocked	In addition to meeting the requirements given in F.6, the suction line must be equipped with a rigid fitting at its end to ensure complete opening.
	Foreign body under the valves	See I.5.1
	Door seal not intact or incomplete	Replace the seal (see I.5.1)
POOR EFFICIENCY	Air entering the suction line	Check pipe seals and possible pipe ruptures.
	Excessively long suction pipeline	Comply with the indications given in F.6 as far as possible
	Excessively worn valves and caps	Proceed with the replacement following the indications given in I.5.1 and I.5.2
	High percentage of gas in pumped liquid	Contact the Technical Service.
	Reversing valve excessively worn	STAINLESS STEEL BALL VALVE Replace the spherical seals. (Contact the Technical Service)
DIFFICULTY IN OPERATING THE VALVE	Build-up of deposits inside the valve Foreign body stuck in the half-open valve	It is advisable to operate the valve frequently (with the machine stopped).
PIPES VIBRATION	Insufficient air cushion in the pulse dampers	Allow air to be sucked in for a short time
	Presence of a foreign body under the valves	See I.5.1
	Restrictions in the suction line	Comply with the indications given in F.6 as far as possible Contact the Technical Service.
LOSS OF THRUST FROM THE GLAND	Worn rings	Replace the entire pack of rings following the indications given in

PROBLEMS	CAUSES	SOLUTIONS
		I.5.3 and I.5.4
	Rods worn out	Replace the rod following the indications given in I.5.3 and I.5.4
LOSS OF LIQUID FROM THE VALVE GLAND	Sealing system loose or worn out	<ul style="list-style-type: none"> • Tighten the seal • Replace the seal (contact the Technical Service)
OIL LEAKS FROM THE GUIDES	Excessive oil level	Check that there have been no liquid infiltrations in the gearbox unit. Replace oil if contaminated.
	Worn guides	Replace the guides (contact the Technical Service).
	Ambient temperature close to the limits of use	Contact the Technical Service.
	Pump placed on an inclined plane	In this case, internal lubrication is reduced. Follow the instructions given in C.3.1
ELECTRICAL MOTOR OVERHEATING: CHECK THE POWER CONSUMPTION ON THE THREE PHASES AND COMPARE IT WITH THE MOTOR'S PLATE VALUES	The load is excessively high for the machine motor power.	Contact the Technical Service.
	Electrical cables too long or with insufficient section	Contact an electrician.
	Mains voltage drop or phase imbalance.	Contact an electrician. Contact your electrical service provider
	Insufficient ventilation	Check that the area around the motor is suitable for proper ventilation, free from dirt and foreign bodies. Check the fan.
NOISE AND THROBS INSIDE THE PUMP	Loose "rod" nut	Tighten it firmly
	Foreign body inside the cylinder	To check if the throbs are caused by the aforementioned reasons, it is necessary to let air into the intake: if the noise stops, it is only caused by the liquid flowing in the cylinders
	Excessive suction head	Comply with the indications given in F.6 as far as possible Contact the Technical Service
	Restrictions in the pipes	
	Pipes with insufficient diameter	
THE ENGINE ROTATES IN THE OPPOSITE DIRECTION WITH RESPECT TO THE ONE INDICATED ON THE BELT COVER	Incorrect connection of the three phases in the connection to the mains	Swap any two phases in the connection.

In case of problems not described above, contact the Technical Service of Ragazzini S.r.l.

I MAINTENANCE

I.1 GENERAL WARNINGS

WARNING: Maintenance technicians must carry out exclusively the maintenance operations described in this chapter. Supervisors and machine maintenance personnel must comply with the prescriptions issued by the Safety Authorities and must also perform all the specific operations listed in this chapter.	
--	---

NOTE: All the information on maintenance concerns solely and exclusively routine maintenance with actions designed to ensure correct daily operation of the machine. If extraordinary maintenance operations are required, contact Ragazzini S.r.l., which will provide specific information.	
--	---

WARNING: All machine maintenance operations must be carried out in a non-explosive atmosphere.	
---	---

- The operations for machine set-up and adjustments must be performed by one person only, under the supervision of the maintenance Supervisor.
- Untrained or unauthorised personnel must not enter the machine working area when the machine is under maintenance.
- Maintenance operations must be carried out in adequate lighting conditions; in case of maintenance work to be carried out in areas with insufficient lighting, use portable worklights; take care to avoid areas of shadow that prevent or reduce visibility on the point in which the work must be performed or on the surrounding areas.

I.2 Precautions and warnings when preparing the machine for routine maintenance.

The maintenance technician must:

- Be aware that there may be hazards in carrying out these operations.
- Comply with all the warnings shown on the machine, on the diagrams, in this document and in the attached documentation to avoid faults that in turn could directly or indirectly cause serious accidents, injuries to persons or damage to property.
- Use the personal protective equipment described in the following paragraph.
- Avoid physical contact with the moving parts of the machine.





The operator must also take into account the following:

ELECTROCUTION HAZARD: Maintenance operations that require the presence of electrical power, such as troubleshooting in the electrical panel, must be performed solely and exclusively by expert personnel, according to the safety procedures in force on the premises in which the machine is installed.	
--	---

WARNING: Any technical modification affecting the operation or safety of the machine must be carried out exclusively by the manufacturer's technical personnel or by technicians formally authorised by the manufacturer. Failure to observe this recommendation exonerates Ragazzini S.r.l. from all responsibility concerning the resulting alterations or any consequent damage. The guards and safety devices may be fully or partly removed during maintenance operations exclusively by expert and/or authorised personnel, who must ensure that all removed safety devices/guards are duly refitted in their original position as soon as maintenance operations have been completed. The machine must not be started up after maintenance operations have been performed until the guards and other safety protections have been refitted.	
---	---

I.3 PERSONAL PROTECTIVE EQUIPMENT

The pump maintenance operator must use the following personal protective equipment:

Pictogram	Description	Note
	FOOTWEAR	Use of safety shoes to avoid the risks generated by falling materials.
	PROTECTIVE GLOVES	Gloves for hand protection available in case of manipulation of objects that can cause damage or injuries.
	HELMET	Protective helmet to be used during machine hoisting operations to prevent the dangers generated by hanging loads.
	SUITABLE CLOTHING	Suitable clothing, such as overalls: it is prohibited to wear wide sleeves and/or loosen clothing that could be easily caught in mechanical parts.
	PROTECTIVE FACE SHIELD	Face shield to be used when working on electrical parts, especially when live

WARNING: The machine does not exceed the noise level established by law; therefore hearing protection earmuffs are not mandatory. However, the operator must also carefully evaluate the environment of use: if it is very noisy, protective earmuffs must be used. When using protective earmuffs, the operator must pay even more attention, as one of the senses of perception of danger (hearing) is missing. Observe the surrounding environment well, as the visual perception must compensate for the lacking sense of hearing.



I.4 PROCEDURES FOR PLACING THE MACHINE IN MAINTENANCE STATUS

Proceed as follows:

- Complete the working cycle in progress.
- Stop the machine.
- Disconnect the electrical supply.
- Fence off the machine and display a “MAINTENANCE IN PROGRESS” sign.

WARNING: Any maintenance work performed on the pump must be carried out with the machine stopped and disconnected from the electrical supply.



WARNING: NO ACCESS TO UNAUTHORIZED PERSONNEL
Do not allow unauthorised persons to approach the machine when maintenance is in progress. Display warning signs next to the disconnecting switches to inform personnel that the machine is stopped for maintenance, in order to limit the risk of accidental and hazardous manoeuvres.



I.5 NORMAL WEAR PARTS

The operations described here below must be carried out by qualified and authorised personnel. The parts subject to wear for routine maintenance are the following:

- Check valves.
- Caps.
- Gland rings.
- Rods.

When there is a decrease in pump performance (indicating a wear of the aforementioned internal parts), it necessary to carry out a check of the parts.

WARNING:

Before opening the pump make sure that the piping is empty and that there is no pressure. The pressure exerted by the fluid could represent a hazard for the operator.



I.5.1 Check and replace the valves

- Unscrew the cap nuts (1).
- Remove the door (2) using the supplied wrench, taking care not to damage the door seals (3). If damaged, replace them.
- Check the condition of the valves (4): absence of deep abrasions and sphericity (resting on their seat without pressure, they must be able to close it perfectly).
- Check that there are no foreign bodies around the valves.
- If necessary, replace the worn valves with new ones (see the table in paragraph J.3).
- Fit the new valves by performing the steps listed above in reverse order.

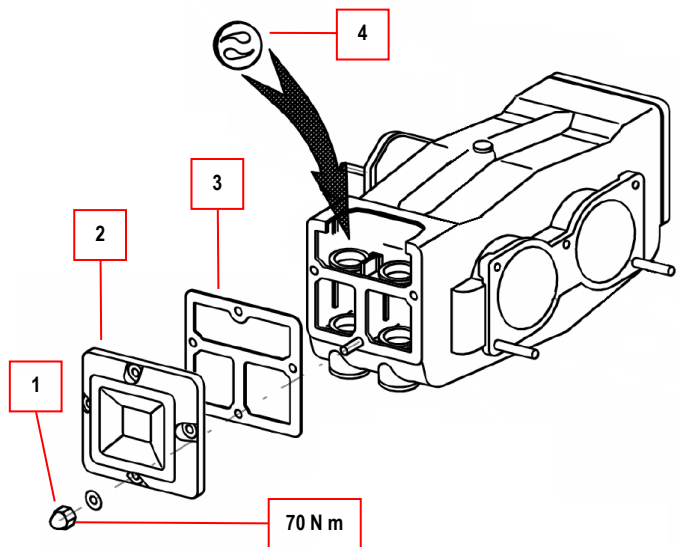

I.5.2 Check and replace the caps

- Loosen the screws (1).
- Remove the front plate (2), taking care not to damage the O-Ring (3).

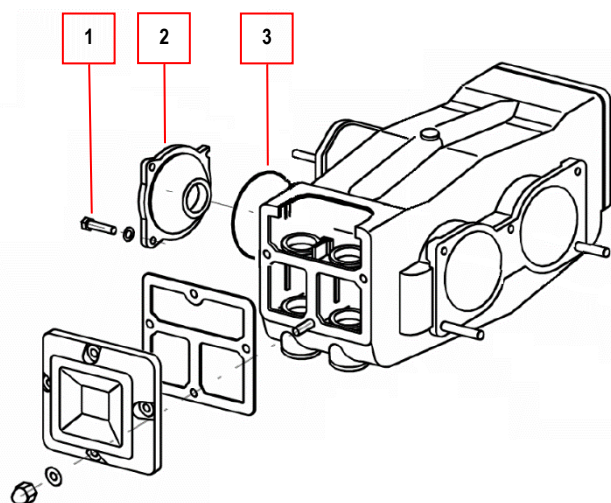

- Remove the retainer (4) and unscrew the crown nut (5).
- Remove the piston holder (6) and the cap (7).
- If necessary, replace the worn caps with new ones (see the table in paragraph J.3).
- Fit the new caps by performing the steps listed above in reverse order.

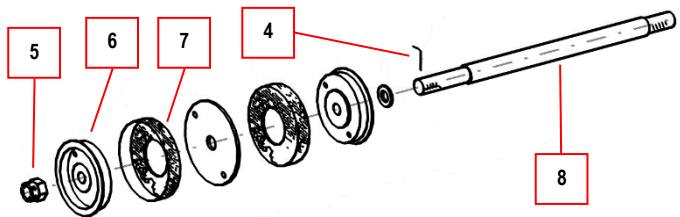

I.5.3 Check and replace the rod seal rings (gland)

- Remove the guard.

Check:

- In case a leak is noticed, tighten the gland nut (1) with the supplied wrench as needed. Proceed gradually.

Replacement:

- Unscrew the gland nut (1) using the supplied wrench.
- Move the gland ring (2) back.
- Remove the worn rings (3) from their seat.
- If necessary, replace the worn rings with new ones (see the table in paragraph J.3).
- Fit the new rings by performing the steps listed above in reverse order.

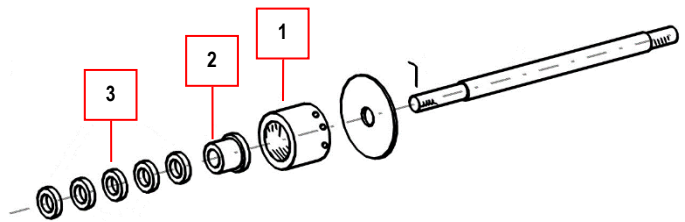

WARNING:

Excessive wear of the rod seal assembly causes:

- Reduced performance.
- Leaks of pumped liquid.
- Possible infiltration of liquids in the oil contained in the gearbox casing.



I.5.4 Rod inspection and replacement

Follow the instructions given in the paragraph “Check and replace the caps”, then unscrew the set screw and unscrew the rod (8) by acting on the hexagon on it.

If necessary, replace the worn rod with a new one (see the table in paragraph J.3).

Fit the new rod by carrying out the steps listed above and the instructions in paragraph “Check and replace the caps” in reverse order. Tighten the gland nut as indicated in the paragraph “Check and replace the rod seal rings (gland)”.

I.6 REPLACEMENT/ADJUSTMENT OF THE BELTS

<p>WARNING: The tensioning of the belts must be checked every 200 working hours. For new pumps and/or belts it is necessary to check the tensioning after a few days of work.</p>	
--	---

- Completely unscrew the screws (1) on the sides of the belt cover (2) and remove the belt cover.

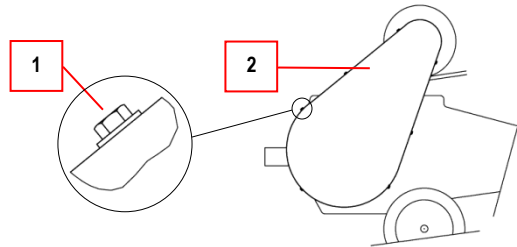



Tensioning:

- Turn the adjustment screw (3) to pull the belts (4) until the appropriate tension is reached. Use a CH24 key.

Replacement:

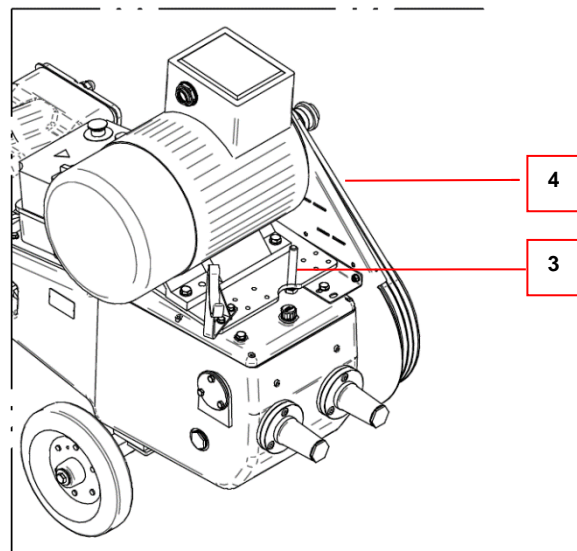
- Turn the adjustment screw (3) to loosen the belts (4).
- Remove the belts.
- Fit the new belts (see the spare parts table, given in paragraph J.3) and, acting on the adjustment screw (3), tension until the appropriate tension is reached.
- Fit the belt cover (2) to bring the machine back to working conditions.



<p>WARNING: Excessive belt tensioning may:</p> <ul style="list-style-type: none"> • Compromise the mechanical parts connected to the belts (shafts and bearings); • Cause premature wear of the belts. <p>Poor tensioning, on the other hand, may cause:</p> <ul style="list-style-type: none"> • Slipping and whistling noises; • Incorrect power transmission; • Belt wear due to rubbing. <p>Tension the belts just enough.</p>	
--	---

I.7 MOTOR / GEARBOX

I.7.1 MOTOR

Follow the attached maintenance instructions or visit the manufacturer's website.

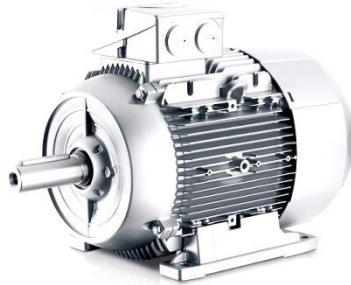

I.7.1 ATEX version

Refer to the documentation contained in the documents folder attached to the machine.



I.7.2 GEARBOX

- Periodically check the oil level in the gearbox through the inspection glass located on the side of the pump.
- Provide a complete oil change every 2000 working hours.
- Use lubricants according to DIN 51517-3 CLP, oil quality: 320° ISO VG.

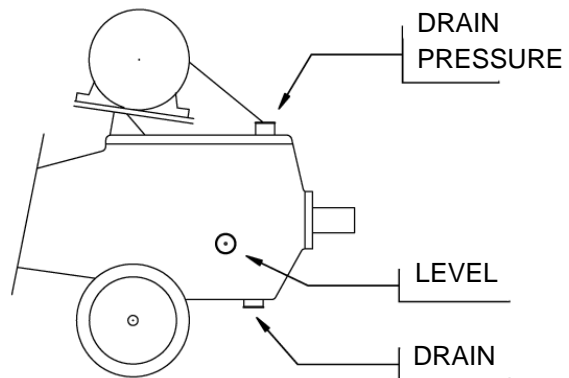

TYPE	Lt	CORRESPONDENCE OF THE MAIN BRANDS LUBRICANTS:	
RC2-Mxl	9.1	MOBIL MOBILGEAR 600 XP 320 PETRONAS GEAR MEP 320 IP MELLANA OIL ISO 320 SHELL OMALA S2 GX 320 TOTAL CARTER EP 320	MINERAL

WARNING:
The quantity of oil shown in the table is indicative. Exact filling must be carried out by checking the level. Always refer to the inspection glass located on the side of the pump.



I.8 COMPONENTS MAINTENANCE – PUMP ATEX VERSION

HAZARD: Maintenance procedures must be performed in the absence of potentially explosive atmospheres.



A periodic cleaning plan must be implemented to avoid a potentially hazardous accumulation of dust on the casing, with > 1 mm thickness.

Clean the oil level plug with a damp cloth, only with water.

The replacement of the bearings must be carried out precautionary every 20000 hours of operation or at the minimum sign of damage. For details on the specific procedure, contact Ragazzini S.r.l. Technical department.

It is mandatory to re-paint any external metal parts of the equipment that have lost their protective paint coating through time. Use paint containing less than 25% by weight of aluminium with a maximum thickness of 0,2 mm.

- If the pressure switch (ATEX certified for gas and dust in category 1 or 2) is to be replaced, a new pressure switch with the same characteristics must be installed.
- If the electrical panel (ATEX certified for gas and dust in category 1 or 2) is to be replaced, a new electrical panel with the same characteristics must be installed.
- If the variator (ATEX certified for gas and dust in category 1 or 2) is to be replaced, a new variator with the same characteristics must be installed.
- If the electric motor (ATEX certified for gas and dust in category 1 or 2) is to be replaced, a new electric motor with the same characteristics must be installed.
- If the wheels must be replaced (ATEX certified in category 1 or 2), new wheels with the same characteristics must be installed.
- If the oil level plug is to be replaced, a new plug with the same characteristics must be installed. Use exclusively original spare parts by Ragazzini S.r.l.
- If the belts must be replaced (ATEX certified in category 1 or 2), new belts with the same characteristics must be installed.
- If the belt cover is to be replaced, a new part with the same characteristics must be installed.
- The “rod-crank” motion transmission system must be continuously lubricated by an oil bath: use a lubricating oil with a minimum flash point by 50K greater than the temperature value $T_4=135^{\circ}\text{C}$ (408.15 K).

J SPARE PARTS

J.1 HOW TO ORDER SPARE PARTS

To avoid misunderstandings and/or shipment of parts that are unsuitable for the intended purpose, include the following identification data in your request of original spare parts:

- Pump model.
- Pump serial number.
- Article code.
- Article description.
- Quantity.
- Type of shipment required.

The identification plate shown here is applied on the pump.

The information on the plate is necessary for identification of the pump.

- A. Pump model.
- B. Serial number.
- C. CE conformity mark (present only when the pump is supplied with motor and control panel).



J.2 SPARE PARTS ORDER EXAMPLE

Pump model: RC2-Mxl

Pump serial number: XXXXXX

Code	Description	Quantity
W018_ _ _ _ _	+ STAINLESS STEEL VALVE_ _ _	N° 1
A803_ _ _ _ _	BELT COVER_ _ _	N° 1

Type of shipment required: Courier: YYYYYY

J.3 SPARE PARTS LIST

HAZARD: For spare parts for ATEX version pumps refer to paragraph I.8 “COMPONENTS MAINTENANCE – PUMP ATEX VERSION”.

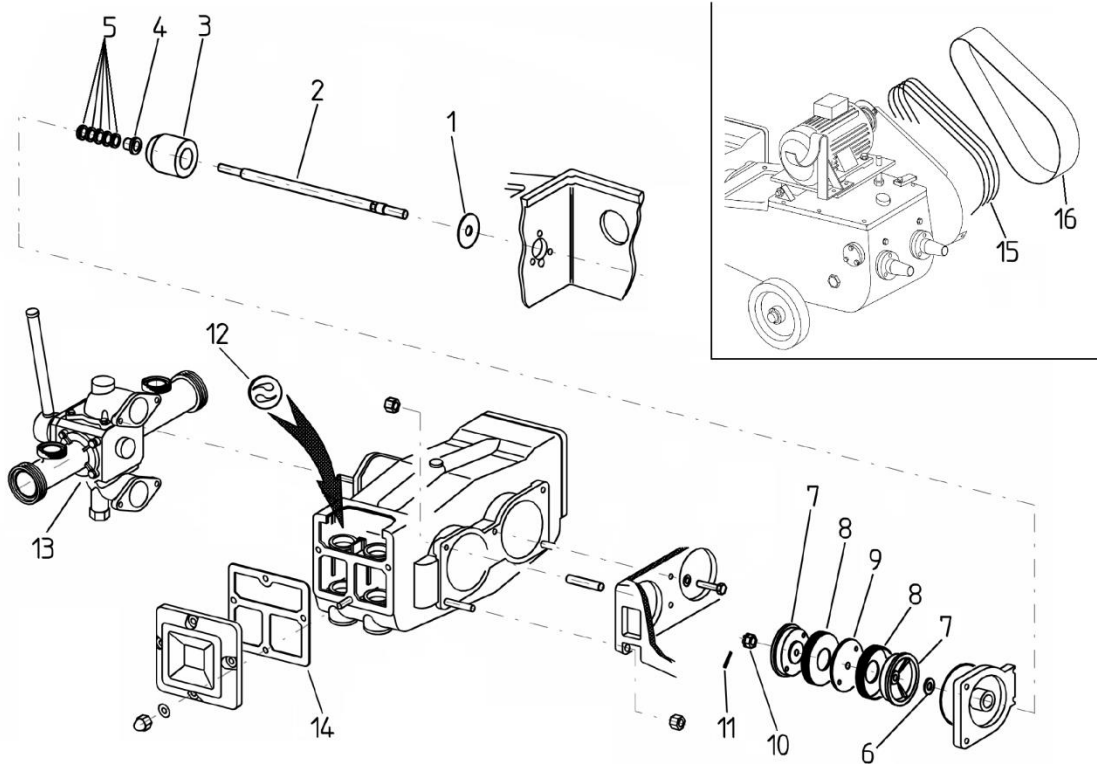

Pos.	Description	ATEX		No.	Code
1	WASHER 95/27/4		✓	2	A9041160A
2	RC2Mxi SHAFT		✓	2	A1020303A
3	6NCM STUFFING NUT		✓	2	A2010381A
4	STUFFING NUT D28		✓	2	A9010261A
5	STUFFING RING (*)	(*)	(*)	-	(*)
6	SHAFT WASHER D22		✓	2	A9040153A
7	RC2-Mxi PISTON DECKING (**)		✓	4	A3050479A
8	RUBBER PISTON DECKING		✓	4	BBG092170
9	CAPS SPACER D 170 (**)		✓	2	A3040322A
10	RETAINER NUT M22x1.5		✓	2	SDAS00000
11	RETAINER NUT		✓	2	A9000435A
12	SPHERE VALVE (*)	(*)	(*)	8	(*)
13	RC2 MXI REVERSER FLOW		✓	1	W01821400
14	5NCM, RC2-Mxi HATCH SEAL		✓	2	A9061747A
15	BELT (**)		✓	4	GESPA1532
16	6NCM BELT COVER	X		1	A8030118A

(*) see paragraph J.4 “Seals”.

(**) standard version, check before ordering.

For parts and/or codes not listed, contact **ragazzini** S.R.L.

J.4 SEALS

The type of use of the pump is of fundamental importance in order to determine the construction material of the components. The optimal choice depends on several factors:

- Fluid to be pumped
- Chemical compatibility
- Working temperature
- Compatibility with food
- Suction capacity
- Expected durability
- Operating pressure

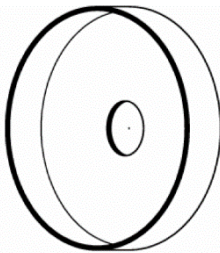

CAPS



VALVES



RINGS

J.4.1 Caps

Usability request made directly to Ragazzini S.r.l. when ordering.

Rubber caps:

- Material suitable for food, wine and must, vinegar, alcohol, oil and hydrocarbons
- Good resistance to chemical aggression
- Good resistance to medium temperatures: max. 100 °C

PLEASE NOTE: Machines with reduced displacements for heavy-duty applications are manufactured on request. Always communicate the serial number of the pump and check the internal diameter of the sleeve with an approximation of 2 mm.

J.4.2 Valves

Usability request made directly to Ragazzini S.r.l. when ordering.

Red valve (PVC):

- Non-toxic
- Good resistance to use with wine, oil and hydrocarbons
- Suitable for use with vinegar (wash with water after use)
- Max temperature 65 °C

Blue valve (PP):

- Non-toxic
- Good resistance to use with alcohols
- Not suitable for use with hydrocarbons
- Max temperature 90°C

White valve (PE):

- Non-toxic
- Good resistance to chemical solvents
- Max temperature 100°C

Pos.	Description	ATEX		No.	Code
12	RED SPHERE VALVE D 80	x		8	BC00P0080
12	BLUE SPHERE VALVE D 80		✓	8	BC00M0080
12	WHITE SPHERE VALVE D 80	x		8	BC00T0080

J.4.3 Rings

Usability request made directly to Ragazzini S.r.l. when ordering.

<p>WARNING: The gland rings are pre-formed; fit them with staggered notches.</p>	
---	---

RAMIE + PTFE (STANDARD or with new rods):

- Non-toxic
- Excellent resistance to use with acid fluids
- Excellent mechanical resistance (stuffing box)
- Max temperature 120°C

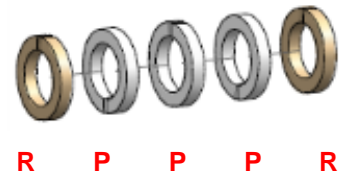

RAMIE (with used rods):

- Non-toxic
- Good adaptability to any scuff marks on the rods
- Max temperature 120°C

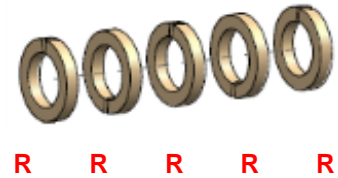

PTFE:

- Non-toxic
- Excellent resistance to chemical agents
- Fair mechanical strength (stuffing box)
- Max temperature 250 °C or max. 135 °C in ATEX environment

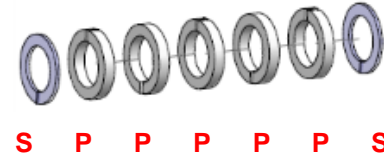

Pos.	Description	ATEX		No.	Code
5R	STUFFING RING RAMIE	x		-	BD1028006
5P	STUFFING RING PTFE		✓	-	BD2028006
5S	RING D28		✓	4	A9012506A

<p>WARNING: Do not dispose of worn sealing parts in the environment. Such parts are similar to urban solid waste and are classified as “special waste”, unless any toxic-harmful pollution exists due to the pumped fluid.</p>	
---	---

J.4.4 Summary table:

	NBR CAP	RED VALVE	BLUE VALVE	WHITE VALVE	RAMIE RINGS	PTFE RINGS
Composition	Nitrile-Butadiene	PVC coated metal core	PP coated metal core	PE coated metal core	/	PTFE
Temperature	<70°C; <100°C	<65°C	<90°C	<100°C	<120°C	<250°C
Compatibility	Compliant to the Italian law D.M. 21/03/1973. Food (temp. <70°C, time <30 min.): - vinegar, - beer, - glucose*, - tartaric acid*, - wine, - must, - ethyl alcohol and ethanol (<40°C). Non-food (temp. <100°C): - hydrocarbons*, - vegetable oils.	- vinegar, - wine, - oil, - hydrocarbons*.	- alcohols, - hydrocarbons*.	- solvents*.		
Mechanical characteristics	Good resistance to chemical aggression. Good resistance to medium temperatures.	Poor resistance to medium-high temperatures.	Good resistance to medium temperatures.	Good resistance to medium temperatures.	Excellent resistance to acid fluids. Excellent mechanical resistance.	Excellent resistance to chemical Fair mechanical resistance.
* These products may be subject to provisions based on their characteristics and pumping conditions. In case of doubts, contact Ragazzini S.r.l. Technical Service.						

K DEMOLITION AND DISPOSAL

K.1 GENERAL WARNINGS CONCERNING DEMOLITION AND DISPOSAL OF THE MACHINE

WARNING: Machine demolition operations must be carried out in a non-explosive atmosphere. 





K.1.1 Special and hazardous waste

- Special waste means residues deriving from industrial processes, materials from the demolition of machines and of deteriorated and obsolete equipment.
- Hazardous waste is waste generated by production activities and containing a significant quantity of pollutants.

WARNING: Disposal of special waste and hazardous waste must be carried out in compliance with statutory legislation. For Italy comply with Legislative Decree 3/4/2006 n. 152, modified by Legislative Decree 3/12/2010, no. 205 and subsequent amendments and additions (“Provisions implementing directive 2008/98/EC”). 

K.2 PERSONAL PROTECTIVE EQUIPMENT REQUIRED DURING MACHINE DEMOLITION AND DISPOSAL

The operator responsible for the demolition and disposal operations must use the following personal protective equipment:

Pictogram	Description	Note
	FOOTWEAR	Use of safety shoes to avoid the risks generated by falling materials.
	PROTECTIVE GLOVES	Gloves for hand protection available in case of manipulation of objects that can cause damage or injuries.
	HELMET	Protective helmet to be used during machine hoisting operations to prevent the dangers generated by hanging loads.
	SUITABLE CLOTHING	Suitable clothing, such as overalls: it is prohibited to wear wide sleeves and/or loosen clothing that could be easily caught in mechanical parts.

K.3 MACHINE DISMANTLING

The qualified and authorised operator responsible for dismantling the machine must:

- For all the required procedures make use of the PPE shown in the above paragraph (K.2).
- Create sufficient space around the machine to perform all movements without risks for persons.
- Disconnect the power supply disconnectors of the machine and lock them in OFF position.
- Disconnect the power supply cable from the disconnector, disconnecting first the power wires and then the protective earth wire.
- Only after performing all the above activities, proceed to dismantle the machine, working from top down and paying special attention to machine parts/units that may fall due to gravity and all components that may contain product residues.

K.4 SORTING THE MATERIALS

After dismantling the machine in accordance with the above indicated procedure, the various materials must be sorted by type:

- Remove the various machine parts from the working area, taking all the necessary precautions.
- Before lifting very large parts, check that the lifting devices are correctly secured and use exclusively adequate harnesses and lifting tackle.
- Sort the various components by type, as far as possible. The parts should be sorted according to material type (plastic, metal, etc.) and then discarded through waste sorting. The parts resulting from the demolition of the machine should be consigned to an authorised waste sorting agency.

HANGING LOADS HAZARD:

Pay the utmost attention when lifting parts of the machine during demolition.



K.5 DISPOSING OF MACHINE MATERIALS AND PRODUCTS

The machine is made of non-hazardous materials, primarily: stainless steel, iron, aluminium, cast iron, copper, plastic and rubber.

These materials are not subject to degradation such as to constitute a risk for operators.

The pump housing contains gear oil.

Prevent waste products from polluting the soil or aquifers and avoid that they are released into the environment.

Disposal must be carried out in compliance with the national regulations in force in the country where the machine is used. Dispose of lubricants in specific locations, intended for the specific purpose.

All electrical and electronic components are purchased by Ragazzini S.r.l. and have already been certified in compliance with Directive 2011/65/EU (RoHS) by their respective manufacturers.

The materials used to protect the machine during transport must be recycled or discarded in compliance with statutory legislation in the destination Country.



Pay attention to the symbol

Disposal must be entrusted to specialised agencies.

L PUMP OPTIONAL CONFIGURATIONS

Optional configurations and accessories available for the piston pump are as follows:

- Pump complete with electric motor and drive components;
- Pump complete with electric motor, drive components and electric control panel;
- Connection fittings with DIN, ENO or MACON connectors (and other types of connections on request);
- Washing kit for compensators;
- Rear wheel brake kit;
- Fixed frame pump;
- Automatic valve;
- Remote controls by wire or radio control

L.1 OPTIONAL MOTOR VERSIONS

The pump may be supplied with:

- Single speed electric motor.
- Double speed electric motor.
- Electric motor controlled by frequency converter.

Follow the attached use and maintenance instructions or visit the manufacturer's website.



L.1.1 ATEX version

Refer to the documentation contained in the documents folder attached to the machine.



L.2 PRESSURE SWITCH

Differential pressure switch for line pressure control.

L.2.1 Technical data

Adjustment range:	0,5 ÷ 8 bar (1)
Differential trip:	0,3 ÷ 5 bar (2)
Sensitivity threshold:	0,2 bar (3)
Max permissible pressure:	30 bar
Contact ratings:	24 V; 6 A
Protection rating -EN 60 529-:	IP 54
Ambient temperature:	- 20 + 70°C
Working fluid temperature:	+70 °C max.

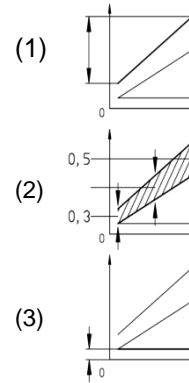

L.2.2 Electrical connections

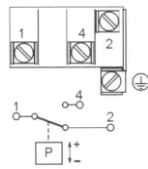

Differential pressure switch; it exchanges the contact at maximum pressure and releases it at reset pressure.

The pressure switch can operate with the following operating logic, depending on the pump model and the electrical panel installed:

- **“Automatic”**: the pump stops when the upper pressure limit is exceeded and restarts automatically when the pressure falls below the reset value
- **“Safety”**: the pump stops when the upper pressure limit is exceeded and restarts only and exclusively after the consent of the operator and with pressure below the reset value.

L.2.3 Calibration

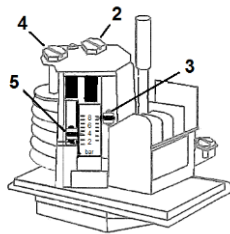

With the calibration screw 2 the upper intervention point is adjusted. Indication with index 3 (red arrow).

With the calibration screw 4 the lower intervention point is adjusted; the upper point remains unchanged. Indication with index 5 (green arrow).

The adjustment scale is not calibrated. For a more precise calibration use a pressure gauge.

Note: the green arrow 5 must never be below the minimum value of the scale.

L.2.4 Overall dimensions

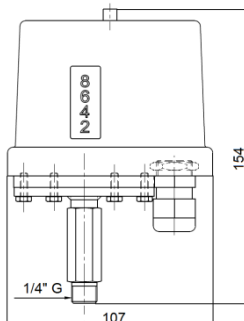

L.2.5 ATEX version

Refer to the documentation contained in the documents folder attached to the machine.

M IDEAL CHARACTERISTIC PERFORMANCE OF THE PISTON PUMP

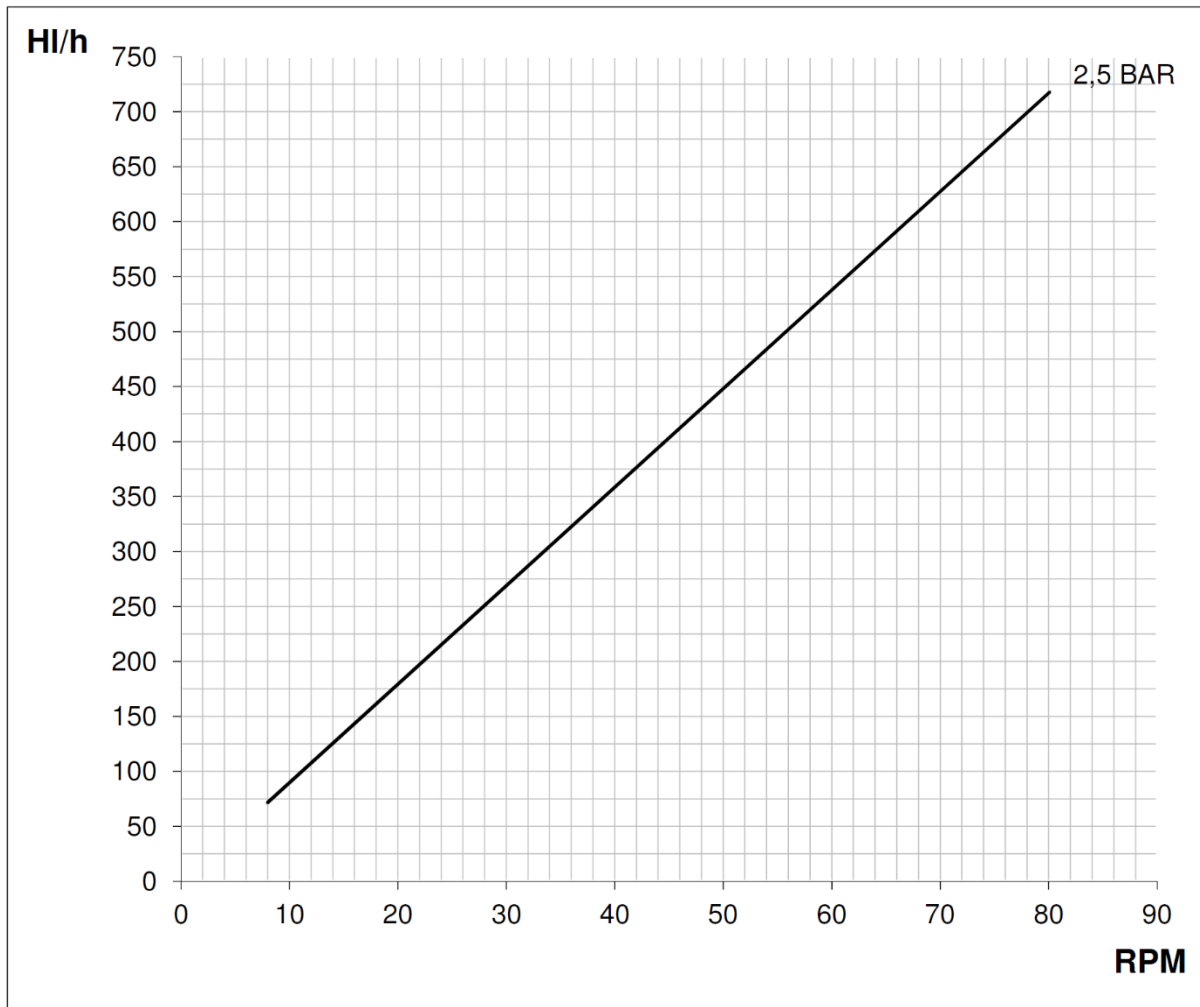

Chart relating to the operation of the pump driven by frequency converter.

- HI/h FLOW RATE (in hectoliters/hour)
- Q% FLOW%
- H SUCTION HEAD (meters of water column)
- RPM PUMP REVOLUTIONS PER MINUTE

These characteristic curves were plotted by pumping pure water (low dissolved gases) at 20°C, pressure of 1 atm, under a low positive head condition and with hoses of identical diameter to the diameter of the pump connections

Fluids with different characteristics can produce major variations:

- Heavy fluids, i.e. with specific density greater than 1
- Viscous fluids
- Hot fluids
- Fluids with high content of gases

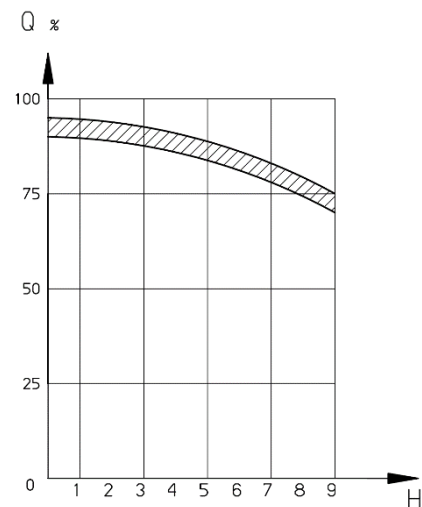



RAGAZZINI SRL – Via A. Volta n.8 48018 Faenza (RA) Italy
Tel: +39-0546-620433 – Fax: +39-0546-621394
Email: rotho@ragazzini.it – Web: www.ragazzini.it

