

# Peristaltic pumps PSF Series

## Model PSF2



## Instructions for use

**Original version in Italian**  
*Third edition - September 2023*

**Document code**  
*LM12EN003*

All rights reserved. The user must not reproduce, save in a data storage system or transmit, in any form and with any means, including mechanical systems, photocopies, recordings or other, any part of this manual without the prior written permission of Ragazzini SRL. Short excerpts appearing in articles in specialised publications are exempt from the above prohibitions.

**ragazzini** s.r.l., **Rotho** and **Rotho·Noxys** are registered trade marks of Ragazzini SRL.

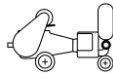
The logos  and  are the property of Ragazzini SRL.

**CONTENTS**

<b>A</b>	<b>CHARACTERISTIC DATA – MACHINE CONFIGURATION</b>	<b>(attached to the machine)</b>	
<b>B</b>	<b>GENERAL WARNINGS</b>		<b>5</b>
B.1	RESPONSIBILITY		6
B.2	ORIGINAL VERSION OF THE INSTRUCTIONS		6
B.3	PRODUCT CONFORMITY		6
B.3.1	COPY OF THE CE DECLARATION OF CONFORMITY		7
B.3.2	MACHINE DATAPLATE		8
B.4	EXPLANATION OF SYMBOLS AND ICONS USED IN THE MANUAL		9
B.4.1	WARNING NOTES		9
B.4.2	DANGER ICONS THAT MAY APPEAR IN THE INSTRUCTIONS FOR USE		9
<b>C</b>	<b>SAFE INTERACTION WITH THE MACHINE</b>		<b>10</b>
C.1	WORK STATION		10
C.2	MAN-MACHINE INTERFACES		10
C.3	INTENDED USE OF THE NON-ATEX VERSION PSF PUMP		10
C.3.1	INTENDED USE OF THE MACHINE		10
C.3.2	PROHIBITED USES		10
C.3.3	REASONABLY FORESEEABLE MISUSE OF THE MACHINE		10
C.4	INTENDED USE OF THE PSF PUMP IN THE VERSION		11
C.4.1	INTENDED USE OF THE MACHINE		11
C.4.2	PROHIBITED USES		11
C.5	GUARDS AND PROTECTION DEVICES		12
C.5.1	ELECTRICAL SAFETY DEVICES (OPTIONAL CONFIGURATION WITH ELECTRICAL PANEL)		12
C.5.2	SAFETY FUNCTIONS IN COMPLIANCE WITH STANDARD EN13849-1		12
C.5.3	NOISE RISK REDUCTION MEASURES		12
C.5.4	EXTREME TEMPERATURE RISKS REDUCTION MEASURES		12
C.5.5	OTHER RISK REDUCTION MEASURES		12
C.6	RESIDUAL RISKS		13
C.6.1	RESIDUAL RISKS DURING NORMAL USE OF THE MACHINE		13
C.6.2	RISKS GENERATED BY TAMPERING AND/OR PROHIBITED CONDUCT		13
C.6.3	RESIDUAL RISKS DURING MAINTENANCE		13
C.6.4	DANGER ZONES		13
C.6.5	RISKS FOR EXPOSED PERSONS		14
C.6.6	INFORMATION AND WARNINGS AFFIXED TO THE MACHINE		14
C.7	PROTECTIVE MEASURES TO BE ADOPTED BY THE USER		15
C.7.1	PERSONAL PROTECTIVE EQUIPMENT		15
<b>D</b>	<b>GENERAL DESCRIPTION</b>		<b>16</b>
D.1	OPERATING PRINCIPLES		16
D.2	DIMENSIONS AND CLEARANCES		17
<b>E</b>	<b>TRANSPORT - STORAGE - LIFTING</b>		<b>18</b>
E.1	GENERAL WARNINGS		18
E.2	PERSONAL PROTECTIVE EQUIPMENT		18
E.3	TRANSPORT		19
E.4	LIFTING AND HANDLING		19
E.5	STORAGE		19
<b>F</b>	<b>INSTALLATION</b>		<b>20</b>
F.1	GENERAL WARNINGS		20
F.2	PERSONAL PROTECTIVE EQUIPMENT		20
F.3	OPERATING AND MAINTENANCE CLEARANCES		20
F.4	PRE-INSTALLATION CHECKS		21
F.5	ELECTRICAL CONNECTION		21
F.5.1	CONFIGURATION WITHOUT ELECTRICAL PANEL		21
F.5.2	OPTIONAL CONFIGURATION WITH ELECTRICAL PANEL		21
F.6	CONNECTION TO THE PRODUCT RECEPTION SYSTEM		22
F.7	PIPES – CORRECT INSTALLATION		23
F.7.1	FLUID PRODUCTS		23
F.7.2	VISCOUS PRODUCTS		23
F.7.3	OVERPRESSURE		23
F.7.4	PUMP STOPPED		23
<b>G</b>	<b>INSTRUCTIONS FOR COMMISSIONING - USE - SHUT-DOWNS</b>		<b>24</b>
G.1	GENERAL WARNINGS FOR ROUTINE MACHINE OPERATION		24
G.1.1	CHECKS AND INSPECTIONS FOR SAFE USE OF THE MACHINE		24
G.2	PERSONAL PROTECTIVE EQUIPMENT		25
G.3	EMERGENCY STOP		25
G.3.1	RESET AFTER AN EMERGENCY STOP		25
G.4	START-UP		26
G.5	USE – START-UP (ROLLER IN WORKING POSITION)		26
G.5.1	ACTIONS TO BE AVOIDED		27
G.6	SHUT-DOWN		27
G.6.1	STOPPING THE PUMP		27
G.6.2	DRAINING THE PUMP		27
G.6.3	FLUSHING THE PIPES		27
G.6.4	PROLONGED STOPS		27

G.7	COMPLIANCE WITH HYGIENE REQUIREMENTS.....	27
G.7.1	DRAINAGE.....	27
G.7.2	CLEANING.....	27
G.8	RESIDUAL RISKS.....	28
G.8.1	USE WITH FOOD FLUIDS.....	28
G.9	PUMP CONFIGURATION - ROLLER SETTING.....	29
G.9.1	SETTING WITH TUBULAR ELEMENT TYPE "PHARMED®".....	30
<b>H</b>	<b>TROUBLESHOOTING.....</b>	<b>31</b>
<b>I</b>	<b>MAINTENANCE.....</b>	<b>33</b>
I.1	GENERAL WARNINGS.....	33
I.2	PRECAUTIONS AND WARNINGS WHEN PREPARING THE MACHINE FOR ROUTINE MAINTENANCE.....	33
I.3	PERSONAL PROTECTIVE EQUIPMENT.....	34
I.4	PROCEDURES FOR PLACING THE MACHINE IN MAINTENANCE STATUS.....	34
I.5	NORMAL WEAR PARTS.....	35
I.6	LUBRICATION.....	35
I.7	TUBULAR ELEMENT REPLACEMENT.....	36
I.8	TUBULAR ELEMENT RUPTURE SENSOR (OPTIONAL).....	38
I.8.1	TECHNICAL DATA.....	38
I.8.2	ELECTRICAL CONNECTIONS (TYPICAL WIRING DIAGRAM).....	38
I.8.3	ATEX VERSION.....	38
I.9	PROLONGED DISUSE.....	39
I.10	COMPONENTS MAINTENANCE – PSF PUMP ATEX VERSION.....	40
<b>J</b>	<b>SPARE PARTS.....</b>	<b>41</b>
J.1	HOW TO ORDER SPARE PARTS.....	41
J.2	EXAMPLE ORDER.....	41
J.3	SPARE PARTS LIST.....	42
<b>K</b>	<b>SCRAPPING AND DISPOSAL.....</b>	<b>43</b>
K.1	GENERAL WARNINGS CONCERNING SCRAPPING AND DISPOSAL OF THE MACHINE.....	43
K.1.1	SPECIAL AND HAZARDOUS WASTE.....	43
K.2	PERSONAL PROTECTIVE EQUIPMENT REQUIRED DURING MACHINE SCRAPPING AND DISPOSAL.....	43
K.3	DISMANTLING THE MACHINE.....	43
K.4	SORTING MATERIALS.....	44
K.5	DISPOSING OF MACHINE MATERIALS AND PRODUCTS.....	44
<b>L</b>	<b>PUMP OPTIONAL CONFIGURATIONS.....</b>	<b>45</b>
L.1	CONFIGURATION WITH ELECTRICAL PANEL.....	46
L.1.1	ATEX VERSION.....	46
L.2	TROLLEY-MOUNTED CONFIGURATION.....	46
L.2.1	ATEX VERSION.....	46
L.3	GEAR UNIT.....	47
L.3.1	ATEX VERSION.....	47
L.4	MOTOR.....	47
L.4.1	ATEX VERSION.....	47
L.5	PRESSURE SWITCH.....	48
L.5.1	TECHNICAL DATA.....	48
L.5.2	ELECTRICAL CONNECTIONS.....	48
L.5.3	CALIBRATION.....	48
L.5.4	OVERALL DIMENSIONS.....	48
L.5.5	ATEX VERSION.....	48
<b>M</b>	<b>IDEAL CHARACTERISTIC EFFICIENCY OF THE PERISTALTIC PUMP.....</b>	<b>49</b>
<b>N</b>	<b>TUBULAR ELEMENT.....</b>	<b>50</b>
N.1	SELECTION CRITERIA.....	50
N.2	DISPOSAL.....	50
N.3	TUBULAR ELEMENT SELECTION GUIDE.....	51

## B GENERAL WARNINGS

- Read the manual carefully before starting any operation.
- The machine must be used as supplied by Ragazzini S.r.l, following all the instructions and indications given in this manual.
- The necessary spare parts for each component will be supplied by Ragazzini S.r.l, otherwise we decline all responsibility for the product and / or the damage it could cause.
- These instructions contain the information necessary to train and inform the operator in order to prevent improper or dangerous use of the machine.
- The instructions must be supplemented by the legislative provisions and the technical standards in force and do not replace any plant standards and any additional prescriptions, even non-legislative, issued in any case for safety purposes.
- These instructions for use constitute an integral part of the machine and must always be kept in good condition and in a safe place where they are readily available to the operator (or anyone else who needs to consult them, as long as said person is duly authorised to use or work on the machine) for the entire service life of the machine.
- If the machine is sold, hired, loaned or leased to others the instruction manual must always be handed over to the new owner/user.
- Check for updates to this document on the site <http://www.ragazzini.it/download/>
- The employer (or its agent) must ensure that its operators read these instructions in their entirety.
- Unfamiliarity with the information and warnings given in this manual can lead to situations of risk for the health and safety of operators.
- The operator must comply with the warnings and procedures set down in these instructions in all stages of the machine's life cycle.
- Peristaltic pumps are machines that present dangerous parts as they are under tension and equipped with movement. Therefore:
  - Improper use.
  - Removing the protections and / or disconnecting the protection devices.
  - Lack of inspections and maintenance.They can cause serious damage to people or things.
- If the operator identifies any differences between the contents of this document and the machine, the supervisor<sup>1</sup> must be informed immediately and the machine must not be used: incorrect or makeshift manoeuvres can be a source of danger for the health of the operator and/or persons near the machine.
- The safety manager must ensure that the machine is handled, installed, put into service, used, put into maintenance and repaired only by qualified personnel who must therefore possess:
  - Specific technical training and experience.
  - Knowledge of technical standards and applicable laws.
  - Knowledge of general national, local and plant safety requirements.
- The machine is intended to be part of an industrial plant. It is the responsibility of the customer (in the figure of the safety manager) to guarantee the overall safety and carry out the analysis of the risks associated with interfacing with other components of the plant.
- Adopt the necessary additional protective measures and related signage.
- The following works cannot be performed without the authorization of the security officer:
  - Installation
  - Plant modifications (configuration or destination of use)
  - Operations on the electrical parts of the machine.

---

<sup>1</sup> Supervisor: person in charge who, informed of the workplace and its occupants, is responsible for supervising the work activities and enforcing compliance with the instructions issued.

## B.1 RESPONSIBILITY

The manufacturer, i.e. Ragazzini S.r.l., is not responsible to:

- Improper use of the machine or for purposes other than those envisaged;
- Failure to follow the instructions for use and maintenance provided by Ragazzini S.r.l.;
- Failure to comply with regulations and safety measures indicated in this manual and / or the additional documentation provided;
- Possible tampering, replacements or modifications (not authorized in writing by the manufacturer, i.e. Ragazzini S.r.l.) of one or more parts of the machine;
- Any intervention that is not part of ordinary maintenance.

Therefore Ragazzini S.r.l. is not responsible for any direct or indirect damage resulting from failure to comply with the above.

## B.2 ORIGINAL VERSION OF THE INSTRUCTIONS

**This document was originally issued in Italian.**

In the event of disputes due to translated versions, even if provided by Ragazzini S.r.l., the only valid text shall remain solely and exclusively the original Italian version.

## B.3 PRODUCT CONFORMITY

The machine described in these instructions is designed and built for installation in industrial premises.

The machine is sold:



- With CE declaration of conformity in compliance with directive 2006/42/EC, Annex II, Point 1 A.
- With CE declaration of conformity in compliance with directive 2014/34/UE, Annex X, letter B (ATEX version).

Any modifications that alter the design and construction features of the machine in terms of place of use, safety and risk prevention may only be made by the manufacturer, which will subsequently certify conformity to the safety standards in force.

Any changes in location, modifications or maintenance operations not contemplated in this document are to be considered unauthorised.

Ragazzini S.r.l. declines all liability if the above safety prescription is disregarded.

**B.3.1 Copy of the CE declaration of conformity:**

	
<p>DICHIARAZIONE DI CONFORMITÀ di una macchina</p>	
<p>(2006/42/CE, All. II, p. 1, let. A) EC Declaration of conformity, Déclaration CE de conformité, Declaración CE de conformidad, EG-konformitätserklärung, Declaração CE de conformidade</p>	
<p>Il fabbricante e Nome e indirizzo della persona autorizzata a costituire il fascicolo tecnico: The manufacturer and name and address of the person authorised to compile the technical file La fabricant et le nom et l'adresse de la personne autorisée à constituer le dossier technique La fabricante y nombre y dirección de la persona facultada para elaborar el expediente técnico Die Hersteller und Name und Anschrift der Person, die bevollmächtigt ist, die technischen Unterlagen zusammenzustellen O fabricante e Nome e endereço da pessoa autorizada a compilar o processo técnico</p>	
<p>Ragazzini S.r.l.</p>	<p>Sede legale: Via A. Volta 8 48018 Faenza (RA) Italy</p>
<p>Dichiara che la pompa: declares that the pump, déclare que la pompe, declara que la bomba, erklärt dass die Pumpe, declara que a bomba</p>	
Tipo – type-son type – tipo – typ – tipo:	Pompa peristaltica
Modello – model-son modèle – modelo – modell-modell:	Serie PSF
Numero di serie-serial number-son numéro de série-número de serie- seriennummer número de serie:	
Funzione – function – fonction – función – funktion-funktion:	Trasferimento prodotti
Anno di costruzione-year of construction-année de construction-año de construcciónbaujahr-ano de construção:	2016
<p>è conforme a tutte le disposizioni pertinenti delle seguenti direttive comunitarie: fulfils all the relevant provisions of the following directives: satisfait à l'ensemble des dispositions pertinentes les directives suivantes cumple todas las disposiciones aplicables de las siguientes directivas comunitarias allen einschlägigen Bestimmungen Folgende Richtlinien entspricht satisfaz todas as disposições relevantes das seguintes directivas</p>	<p>2006/42/CE 2014/30/UE</p>
<p>e alle seguenti norme armonizzate, norme e/o specifiche tecniche applicate: and under the following harmonised standards, technical standards and/or specifications used: et la suivante normes harmonisées, normes et/ou specifications techniques qui ont été utilisées: y la siguiente normas armonizadas, normas y/o especificaciones técnicas que se hayan utilizado: und die folgende harmonisierten Normen, technischen Normen und/oder Spezifikationen angewandt: e a seguir normas harmonizadas, normas e/ou especificações técnicas que tiverem sido utilizadas:</p>	<p>EN ISO 121100:2010</p>
<p>Luogo-Place-Lieu-Lugar-Ort-Local: Faenza (RA) Data-Date-Date-Fecha-Datum- 01/07/2016 Data:</p>	<p style="text-align: right;">   <b>RAGAZZINI S.r.l.</b>  <b>Zaffagnini Alberto</b>  <b>Legale Rappresentante</b> </p>

**B.3.2 Machine dataplate**

The pump is identified by type, serial number, and year of construction, as shown on the dataplate affixed to it.

Heed the following warnings at all times:

- Do not remove the dataplate from its original position;
- Do not alter or falsify the technical data;
- Do not clean the dataplate with abrasive tools (e.g. wire brushes) or the data may become illegible.



**NOTE:** All information on the dataplate must remain legible at all times. Use the identification data in all communications with the manufacturer, e.g. requests for replacement parts, information, and technical assistance. If the dataplate becomes defaced through time or if any of the data are illegible, request a replacement from the manufacturer, quoting the data given in this manual or on the original dataplate.



**B.4 EXPLANATION OF SYMBOLS AND ICONS USED IN THE MANUAL**

**B.4.1 Warning notes**

Warnings concerning possible risks for the operator's health and safety are shown with warning notes accompanied by the specific danger icon (see heading B.4.2 "Danger icons that may appear in the instructions for use"); the text of warning notes is shown on a yellow background.

Warning note example:

<b>MOVING PARTS HAZARD:</b> Do not remove or tamper with the guards.	
--	---

The specific instructions / warnings for ATEX pumps are shown as indicated below (the text of the note is shown on a yellow background and accompanied by the icon for environments at risk of explosion and/or fire).







Note text	
-----------	---

Instructions that may, if disregarded, result in impairment of machine operation are shown as follows:

Note text	
-----------	--

**B.4.2 Danger icons that may appear in the instructions for use**

The following danger icons are used in this manual:

	<b>DANGER</b>		<b>ELECTROCUTION</b>		<b>MOVING PARTS</b>
	<b>SUSPENDED LOADS</b>		<b>HIGH TEMPERATURES</b>		<b>DANGEROUS SUBSTANCES</b>

## C SAFE INTERACTION WITH THE MACHINE

### C.1 WORK STATION

Refer to the client's production line.

### C.2 Man-machine interfaces

Refer to section L "PUMP OPTIONAL CONFIGURATIONS" for information on the commands to be used by the operator, if present.

### C.3 INTENDED USE OF THE NON-ATEX VERSION PSF PUMP

#### C.3.1 Intended use of the machine

PSF series peristaltic pumps are designed and manufactured by Ragazzini Srl for suction and transfer of both solid and liquid products with suspended solid parts of up to 45% of the inside diameter of the tubular element.

#### Environmental limits:

- Ambient temperature: between -10°C and 40°C.
- Working environment: indoor or outdoor with protection from direct sunlight and weather.
- Lighting: The place of installation must be adequately lit (minimum 200 lux).

**ANY OTHER USE OF THE PUMP OUTSIDE THE ABOVE DESCRIBED USE IS PROHIBITED BY THE MANUFACTURER.**

#### C.3.2 Prohibited uses.

#### The machine must not be used:

- For operations other than those described under heading C.3.1 "Intended use of the machine".
- In outdoor sites or in enclosed premises not equipped with a lightning protection system.
- In places exposed to direct sunlight.

#### Limitations on machine use:

#### Do not:

- Use the machine in a configuration other than the configuration envisaged by the manufacturer.
- Use the machine in places subject to the risk of explosion and/or fire (the machine is not certified in compliance with ATEX directive 2014/34/UE).
- Use the machine with fluids at temperatures above the maximum permissible temperatures for the suction hose.
- Pump products with suspended solid parts in excess of 45% of the inside diameter of the tubular element.
- Incorporate other systems and/or equipment not contemplated by the manufacturer during the executive design phase.
- Remove machine components or parts.
- Operate when the machine is stopped before disconnecting electricity. The machine can have a remote driving consent ("auto") or a remote control and can restart suddenly.
- Move the machine if connected to the electricity supply.

#### C.3.3 Reasonably foreseeable misuse of the machine

#### Do not:

- Tamper with the machine or any one of its safety devices;
- Tamper with the movable and/or fixed guards;
- Bypass the safety devices;
- Climb onto the machine and/or pass over it.

**C.4 INTENDED USE OF THE PSF PUMP IN THE VERSION****C.4.1 Intended use of the machine**

PSF series peristaltic pumps are designed and manufactured by Ragazzini Srl for suction and transfer of both solid and liquid products with suspended solid parts of up to 45% of the inside diameter of the tubular element.

**Environmental limits:**

- Ambient temperature: between -10°C and 40°C.
- Working environment: indoors or outdoors, with protection from direct sunlight and the weather, environment classified as ATEX zone II 2G h IIB T4 Gb - II 2D h IIB T=135°C Db.
- Lighting: The place of installation must be adequately lit (minimum 200 lux).

**ANY OTHER USE OF THE PUMP OUTSIDE THE ABOVE DESCRIBED USE IS PROHIBITED BY THE MANUFACTURER.**

**C.4.2 Prohibited uses.****The machine must not be used:**

- For any operations other than those described under heading C.4.1 "Intended use of the machine".
- In places with temperatures outside the range -10°C to +40°C.
- Near equipment that generates stray electrical currents.
- In outdoor sites or in enclosed premises not equipped with a lightning protection system.
- In places exposed to direct sunlight.

**Limitations on use of the machine:****Do not:**

- Use the machine in a configuration other than the configuration envisaged by the manufacturer.
- Use the machine in Zone 0-20 classified areas.
- Use the machine in areas subject to the presence of gas having a flash point below 135°C.
- Use the machine in areas subject to the presence of IIC classified gases.
- Pump products at a temperature in excess of 40°C; exceeding this limit does not allow compliance with the temperature class.
- Pump products with suspended solid parts in excess of 45% of the inside diameter of the tubular element.
- Incorporate other systems and/or equipment not contemplated by the manufacturer during the executive design phase.
- Remove machine components or parts.
- Use the pump in case of product / pumped fluid leaks.

**C.5 GUARDS AND PROTECTION DEVICES**

The machine is equipped with the safety protections required to prevent injury to the operator and damage to the machine. The machine is equipped with a fixed guard to protect its potentially dangerous elements, secured by means of fasteners that cannot be removed without tools. The other moving parts (motor, gear unit) are commercial components that are already certified by their manufacturers.

<b>MOVING PARTS HAZARD: Do not remove or tamper with the guards.</b>	
--	---

**C.5.1 Electrical safety devices (optional configuration with electrical panel)**

The machine can be equipped with an electrical panel complete with controlgear. The commercial components forming part of the electrical equipment are identified and CE marked and they are accompanied by their respective CE Declarations of Conformity. The machine is equipped with a red mushroom head emergency pushbutton on a yellow backplate located on the electrical panel.

<b>ELECTROCUTION HAZARD:</b> In the event of a fire outbreak near the machine (or on the machine itself), never use water or any other aqueous or wet extinguishing media as this could lead to a risk of electrocution by indirect contact.	
--	---

**C.5.2 Safety functions in compliance with standard EN13849-1**

The safety<sup>2</sup> functions described below are implemented on the machine:

Safety Function	PL <sup>3</sup>
Pump stops when emergency stop pushbutton is pressed	c
Pump stops due to tubular element rupture sensor trip	c
Pump stops due to pressure switch trip (if present)	c

For the pressure switch data sheet, see paragraph L.5 “PRESSURE SWITCH”.

**C.5.3 Noise risk reduction measures**

The values given below refer to measurements made on a pump manufactured by Ragazzini S.r.l., technically comparable and representative of the machine described in these instructions.

The noise level of all other machines manufactured by Ragazzini S.r.l is lower than the noise level shown.

Type	DF 190
Serial number	DF159748
A-weighted sound pressure level of noise emissions in the workplace	76.6 dB(A)

**C.5.4 Extreme temperature risks reduction measures**

<b>HIGH TEMPERATURES HAZARD:</b> when pumping fluids having a constant temperature in excess of 60°C suitable warning signs or shielding must be provided.	
--	---

**C.5.5 Other risk reduction measures**

<b>DANGER:</b> The machine is not equipped with lightning protection and must be installed in lightning protected sites.	
--	---

<sup>2</sup> The definition of safety function is reported in the UNI EN ISO 13849-1 standard; a safety function is a function of the machine whose failure can lead to an immediate increase in the risk related to the machine itself.

<sup>3</sup> The PL (Performance Level): in the UNI EN ISO 13849-1 standard the Performance Level is defined as a discrete level used to specify the ability of safety related control parts to perform a safety function in the conditions envisaged. It is assigned 5 values, from PLa to PLe with increasing risk (PL = e> PL = d> PL = c> PL = b> PL = a).

**C.6 Residual risks**

**Risks resulting from:**

- Operator distraction,
  - Failure to observe the information and prescriptions provided in this manual,
  - Improper uses of the machine;
- cannot be totally eliminated by inherently safe design due to the machine construction type.

The following information concerns residual risks that persist despite adoption of the protective measures described in the present manual.

**WARNING:** All machine handling, installation, maintenance and scrapping operations must be carried out in a non-explosive atmosphere. 

**C.6.1 Residual risks during normal use of the machine**

No operator hazards are present during normal machine operation if the guards are intact and correctly installed, because movements that can produce risk conditions are adequately protected by guards.

**C.6.2 Risks generated by tampering and/or prohibited conduct**

Following tampering and / or incorrect assembly of the protection devices (fixed guards) and / or mobile devices (if present) and subsequent start-up of the machine, the following residual risks connected to hazards of a mechanical nature will be present:

List of hazards		Hazard condition identification			Detailed description of the risk
Type or group	Source	Potential consequences	Danger zone	Life cycle stages	
Mechanical	High Pressure	Projection of objects Friction/abrasion	Machine area	Production Maintenance Adjustment	Risk of damage due to the expulsion of objects or fluids under pressure during operation or when the machine is stationary due to residual pressure in the pipes or parts of them clogged.
Mechanical	Rotating elements	Drawing in and entrapment Crushing Shearing	Machine area	Production Maintenance Adjustment	Risk of contact between moving parts of the machine (presser rollers, driveline components, motor, gear unit) and parts of the operator's body

Another source of risk for the operator caused by prohibited conduct can arise due to failure to use adequate P.P.E. (Personal Protective Equipment).

**C.6.3 Residual risks during maintenance**

During machine maintenance it is reasonably foreseeable that injury may occur to:

- Upper limbs (abrasion on mechanical components)
- Lower limbs (falling of inadequately supported mechanical parts),
- Eyes (hazards generated by pressurised fluids and elements under tension),
- The head (contact with machine components).

If the emergency stop pushbutton is pressed only the power feeding cables remain energised.

**C.6.4 Danger zones**

On the basis of the above considerations, the following are to be considered danger zones:

- The internal area of the machine, during execution of the production cycle with guards tampered with or removed;
- (Optional configuration with electrical panel) the space alongside electrical panels with door open and power connected, during troubleshooting operations.

**C.6.5 Risks for exposed persons**

Exposed persons are persons not involved in running the machine and hence other plant workers or visitors. These instructions do not address problems external to the machine user company so persons near the company premises are not classified as exposed persons.

This type of machine is not associated with risks for exposed persons during operation (with electrical panel door closed and machine in maximum safety conditions).

<p><b>WARNING: NO ACCESS BY UNAUTHORISED PERSONS</b></p> <p>During normal operation ensure exposed persons are kept at a safe distance from the danger zones.</p> <p>During maintenance: do not allow extraneous persons to approach the machine under any circumstances. Cordon off the area surrounding the machine and display warning signs to the effect "MAINTENANCE IN PROGRESS" around the area, if deemed necessary.</p>	
---	---

**C.6.6 Information and warnings affixed to the machine**

After identifying several residual risks the machine has been equipped with warning decals defined in compliance with European and international standards concerning the graphic symbols to be used on plants (EN ISO 7010).

The client must replace any defaced or illegible warning decals immediately.

The following warning decals are affixed to the machine:

**Do not remove the guards**



**You must read the instructions**









<p><b>WARNING:</b></p> <p><b>Do not remove the warning signs and decals affixed to the machine.</b></p> <p>Ragazzini S.r.l. declines all liability for machine safety if the above prohibition is disregarded.</p>	
--	---

**C.7 Protective measures to be adopted by the user**

**C.7.1 Personal protective equipment**

To protect the operator's health and safety during the various stages of the machine life cycle, it is mandatory to use (or to have access to) the P.P.E. (Personal Protective Equipment) indicated below. The manufacturer requires clients to use the machine with CE marked P.P.E. in compliance with the directive concerning personal protective equipment. The operator must comply with the directive, which sets out the methods of use of personal protective equipment during work activities. Since it is impractical to predict all possible machine operating conditions, the P.P.E. listed refer only to use of the machine: the employer must prescribe the use of any additional P.P.E. required in compliance with the actual situation in the production site.

PPE to be used during the various stages of the machine's life cycle			
Icon	Description	Machine life cycle stages	Notes
	FOOTWEAR	<ul style="list-style-type: none"> <li>• transportation;</li> <li>• installation;</li> <li>• use;</li> <li>• maintenance;</li> <li>• dismantling and scrapping</li> </ul>	Use safety footwear to protect against the risk of falling objects.
	DIELECTRIC FOOTWEAR WITHOUT METAL PARTS FOR USE BY ELECTRICIANS	<ul style="list-style-type: none"> <li>• maintenance of electrical components</li> </ul>	Use dielectric safety footwear to protect against hazards generated by direct or indirect contact.
	PROTECTIVE GLOVES	<ul style="list-style-type: none"> <li>• transportation;</li> <li>• installation;</li> <li>• maintenance;</li> <li>• dismantling and scrapping</li> </ul>	Safety gloves must be available for handling objects that could cause hand injuries.
	INSULATED PROTECTIVE GLOVES	<ul style="list-style-type: none"> <li>• maintenance of electrical components</li> </ul>	Use protective insulating gloves to protect against hazards generated by direct or indirect contact
	HARD HAT	<ul style="list-style-type: none"> <li>• transportation;</li> <li>• installation;</li> <li>• use;</li> <li>• maintenance;</li> <li>• dismantling and scrapping</li> </ul>	A hard hat must be worn during machine lifting operations to protect against hazards generated by suspended loads.
	SUITABLE CLOTHING	<ul style="list-style-type: none"> <li>• transportation;</li> <li>• installation;</li> <li>• use;</li> <li>• maintenance;</li> <li>• dismantling and scrapping</li> </ul>	Suitable clothing such as overalls. Do not wear clothing with loose sleeves and/or other loose items which could easily be drawn in by the mechanical parts of the machine.
	VISOR	<ul style="list-style-type: none"> <li>• maintenance</li> </ul>	Protective face shield when working on electrical parts, especially with energy connected.

<p><b>CAUTION:</b> Machine noise levels are below the noise emission limit established by law so the use of hearing protectors is not compulsory. However, the operator must consider the operating environment: if it is very noisy, hearing protectors must be worn. If earmuffs are used, the operator must take even greater care when using the machine due the contingent reduction in hearing sensitivity. Observe the surrounding environment carefully and use your eyes to compensate for your reduced hearing.</p>	
---	---

**D GENERAL DESCRIPTION**

The peristaltic pump can be composed of the following elements (indicative image):

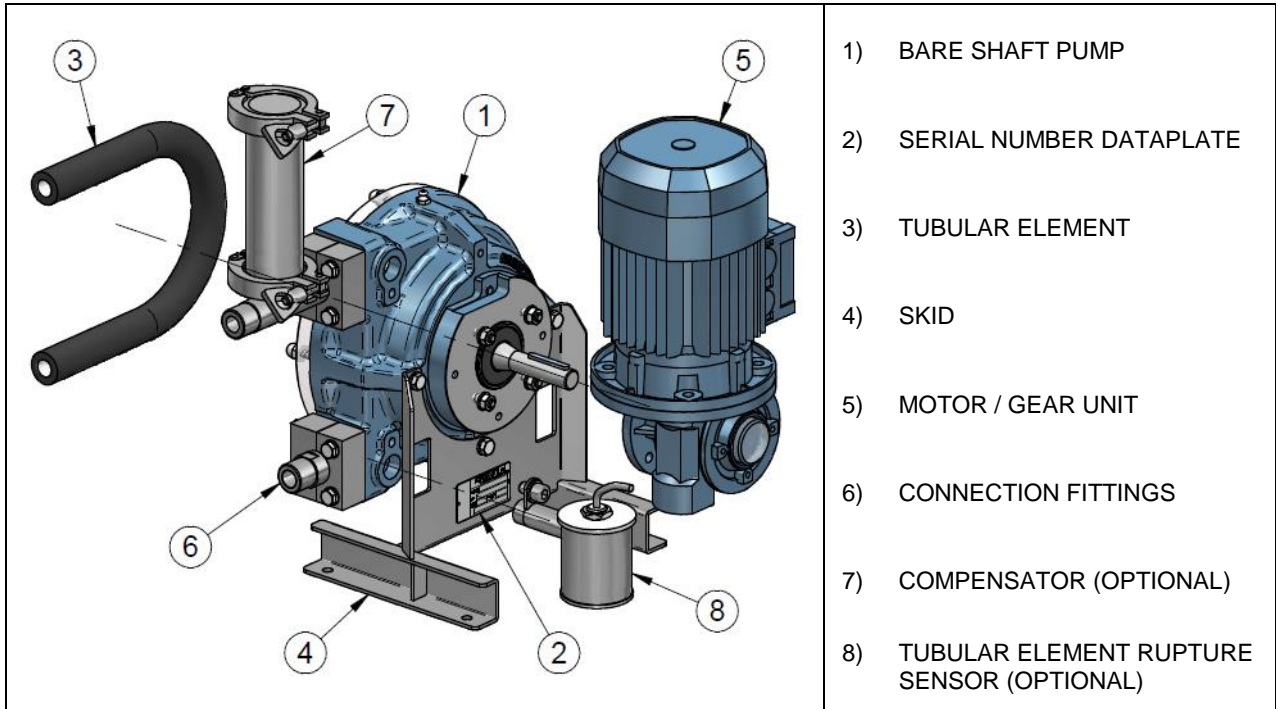

**D.1 OPERATING PRINCIPLES**

The tubular element in the peristaltic pump is progressively compressed by the rollers; the alternation between compression and relaxation of the hose generates a continuous suction flow (downstream of the roller) and delivery flow (upstream of the roller).

Dry running (pump empty) does not cause damage.

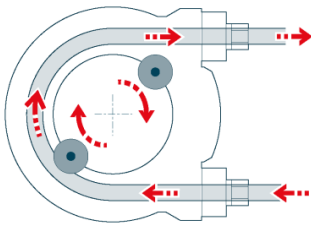

Pump operation is reversible

The flow rate is proportional to the motor rpm

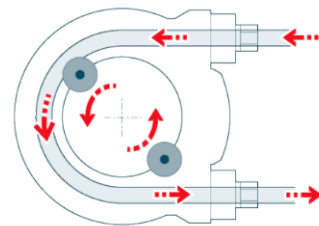



**D.2 DIMENSIONS AND CLEARANCES**

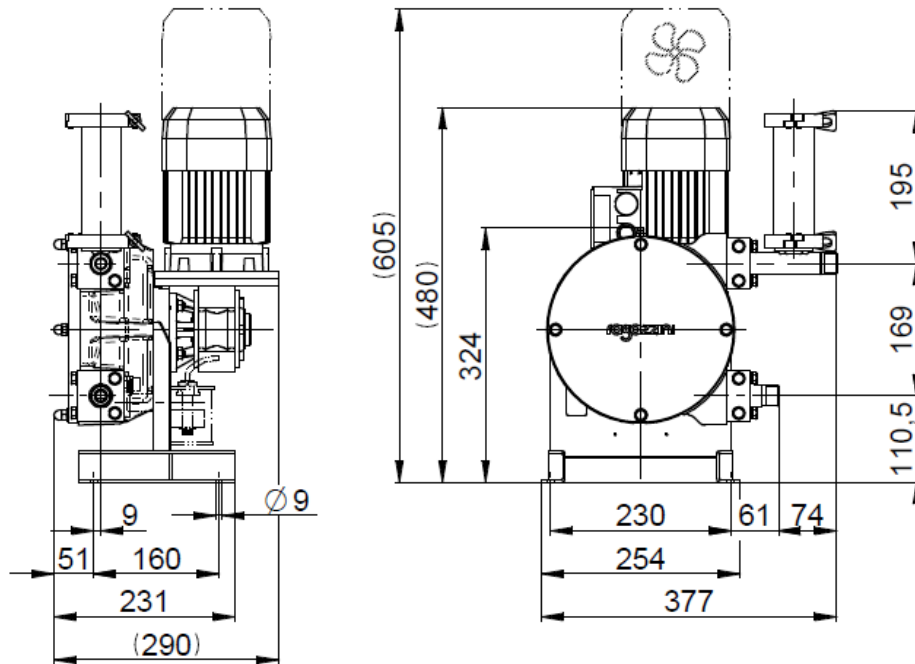

The images above are purely indicative, for further details or references to dimensions for specific configurations, please contact the Ragazzini S.r.l. technical assistance service.

**E TRANSPORT - STORAGE - LIFTING**

**E.1 GENERAL WARNINGS**

The operator responsible for transporting, lifting and storing the machine must:

- Be adequately trained and informed in relation to the job in hand;
- Use the personal protective devices listed in the following heading (see heading E.2);
- Use suitable equipment to perform the operations in conditions of safety and check that the equipment in question is in perfect working order;
- Use all the service equipment as prescribed by the related manufacturers.

Before handling the machine, check the load capacity and good working order of the lifting equipment:

<p><b>DANGER:</b> To lift the machine or parts of the machine, use lifting equipment of minimum load capacity in relation to the stated weight of the machine (See document "CHARACTERISTIC DATA - MACHINE CONFIGURATION" attached to the pump documents).</p>	
--	---

Perform lifting and transport operations taking account of the following warnings:





<p><b>DANGER - SUSPENDED LOADS:</b> When lifting the machine makes sure there are no exposed persons in the area occupied by the machine and in the immediately surrounding areas. The machine must be lifted smoothly without any abrupt movements. During lifting and transporting operations the machine must always be kept in a safe and stable position. Keep the load as close to the ground as possible when moving it to achieve optimal conditions of stability.</p>	
--	---

<p>During lifting avoid abrupt movements that could damage the machine.</p>	
---	---

<p><b>WARNING:</b> All machine handling operations must be carried out in a non-explosive atmosphere.</p>	
---	---

**E.2 PERSONAL PROTECTIVE EQUIPMENT**

The operator responsible for the pump transport, lifting and storage operations must use the following personal protective equipment:

Icon	Description	Notes
	FOOTWEAR	Use safety footwear to protect against the risk of falling objects.
	PROTECTIVE GLOVES	Safety gloves must be available for handling objects that could cause hand injuries.
	HARD HAT	A hard hat must be worn during machine lifting operations to protect against hazards generated by suspended loads.
	SUITABLE CLOTHING	Suitable clothing such as overalls. Do not wear clothing with loose sleeves and/or other loose items which could easily be drawn in by the mechanical parts of the machine.

**E.3 TRANSPORT**

The pump must be handled by means of suitable mechanical lifting equipment.  
The pump is protected by pack consisting of a solid base (pallet) and a cardboard case.

The packing materials are recyclable.



During transportation the pump is in its inoperative state in order to protect the condition of the tubular element  
For the first start-up see chapter G "INSTRUCTIONS FOR COMMISSIONING - USE - SHUT-DOWNS"

**E.4 LIFTING AND HANDLING**

See document "CHARACTERISTIC DATA - MACHINE CONFIGURATION" attached to the pump documents, for the weight of the machine.  
If the weight is less than 25 kg it is possible to perform manual pump lifting paying attention to the following behavior notes:

<p><b>WARNING:</b> Observe the provisions of national laws regarding the manual lifting of loads.</p>	
---	--

- Do not manually lift the pump to a height greater than 1400 mm from the walking surface.
- Keep the load close to the body, avoid twisting the trunk, bend the legs.

For further details refer to ISO 11228-1.

**E.5 STORAGE**

The pump must be in set in its inoperative configuration in order to maintain the working life of the tubular element. Avoid outdoor sites, sites exposed to the weather or excessively humid sites: place the pump away from direct sunlight and heat sources, contamination, floods and drains. Place the pump in a safe area, outside the hazardous areas , in areas forbidden to unauthorized personnel. It leaves at the discretion of the customer the protection from dust, dirt, animals.  
For storage periods exceeding 60 days, protect any mating surfaces (gearbox or motor flanges) with suitable antioxidant products.

<p>Replacement tubular elements must be stored in a dry place and protected from the light.</p>	
---	--

**F INSTALLATION**

**F.1 GENERAL WARNINGS**





The machine installation operator must:

- Be adequately trained and informed in relation to the job in hand;
- Use the personal protective devices listed in heading F.2;
- Use suitable equipment to perform the operations safely and check that the equipment in question is in perfect working order;
- Use all the servicing tools prescribed by the related manufacturers.

**WARNING:** All machine maintenance must be carried out in a non-explosive atmosphere. 

**F.2 PERSONAL PROTECTIVE EQUIPMENT**

The operator responsible for pump installation operations must use the following personal protective equipment:

Icon	Description	Notes
	FOOTWEAR	Use safety footwear to protect against the risk of falling objects.
	PROTECTIVE GLOVES	Safety gloves must be available for handling objects that could cause hand injuries.
	HARD HAT	A hard hat must be worn during machine lifting operations to protect against hazards generated by suspended loads.
	SUITABLE CLOTHING	Suitable clothing such as overalls. Do not wear clothing with loose sleeves and/or other loose items which could easily be drawn in by the mechanical parts of the machine.

**F.3 OPERATING AND MAINTENANCE CLEARANCES**

The place in which the machine is to be installed must be well lit and ventilated, distant from heat sources, and able to ensure proper operation of the machine, considering especially access to the commands and access for maintenance activities.

The surrounding free space must be 500 ÷ 800 mm.

Install the pump on anti-vibration mounts to reduce vibration.

If the pump must be positioned outdoors, it must be protected from direct sunlight and the weather.

**DANGER:** The machine is not equipped with lightning protection and must therefore be installed in protected environments. 

**F.4 PRE-INSTALLATION CHECKS**

Once removed from the packing, check the machine for surface abrasion or damaged parts.  
 The materials that make up the packaging are recyclable.  
 Check that the mains voltage is commensurate with the motor input voltage.  
 Check the diameter of the fittings to be connected to the pump.



**HIGH TEMPERATURES HAZARD:** Make sure the type of tubular element installed is suitable for the intended use. If the pumped fluid constant temperature exceeds 60°C, the pump casing can reach dangerous temperatures for direct contact: install suitable warning signs and shielding.



**F.5 ELECTRICAL CONNECTION**

**F.5.1 CONFIGURATION WITHOUT ELECTRICAL PANEL**

The electrical control panel and the connecting cables must be in compliance with the applicable regulations (see also paragraph L.1).

The electrical panel must be suitably configured for:

- Reversal of the direction of rotation;
- Control of the electrical components.

If the control panel is in a remote position, install a start pushbutton and a stop/emergency pushbutton in the immediate vicinity of the machine. No means shall be provided to disable said controls from the electrical panel to be used for maintenance purposes.

**DANGER:** if the machine is not supplied in the configuration with an electrical panel, it is the client's responsibility to equip it with an emergency stop pushbutton.



Install a power supply disconnect device in the fixed wiring circuit. The disconnect device must be padlockable in the open (disconnected) position.

**ELECTROCUTION HAZARD:** During maintenance operations on the pump or for operations carried out on the electrical components the machine must be at a standstill and disconnected from the electrical power supply.



**F.5.2 OPTIONAL CONFIGURATION WITH ELECTRICAL PANEL**

For correct operation of the machine, these operations must be performed on completion of machine positioning and fixing.

**B.1.1.1 Electrical power supply connection**

The machine must be connected to the mains supply by a licensed electrician in compliance with the technical standards and safety regulations force (see also paragraph L.1).

The machine must be connected to a protected earth circuit of proven efficiency.

If in doubt concerning efficiency of the protective earth circuit, do not connect the machine.

The user must install an adequate disconnect switch on the machine power feeding line and shall also install efficient surge current and indirect contact protective devices.

Efficient surge current protections include the following elements (correctly sized and adapted to the characteristics of use):

- Fuses,
- Automatic cut-outs,
- Circuit breakers.

Efficient indirect contact protections include:

- Residual current devices,
- Fault sensors.

When hooking up the machine check:

- That the data of the power supply network correspond to the electrical data indicated in the wiring diagram attached to the machine (an incorrect power supply voltage can damage the machine);
- That the mains power supply is adequately earthed;

The correct positioning and fastening of:

- Guards,
- Microswitches,
- Emergency stop pushbutton.

Hook up the machine electrical panel using suitable cables in relation to machine input current.

Use suitable connection accessories (cable lugs, screws, etc.) in relation to the conductor to be connected and the input current; said devices must be assembled in accordance with the manufacturer's instructions and observing best technical practices.

Use wiring accessories (sheaths, junction boxes, etc.) able to maintain the electrical panel IP protection rating.

For the description of the commands, refer to the attached documentation.

## F.6 CONNECTION TO THE PRODUCT RECEPTION SYSTEM

**SUCTION:** the pump must be positioned as close as possible to the fluid source, in order to use a suction pipe of minimum length and as straight as possible. Avoid tight turns.

<p>The suction pipe must be airtight and of construction material able to withstand the internal pressure. The minimum pipe diameter must be identical to the diameter of the tubular element. When pumping viscous fluids use larger diameters.</p>	
--	---

The pump is self-priming and does not therefore require a foot valve.

**DELIVERY:** to reduce machine power consumption use the shortest and straightest possible pipelines. Avoid tight turns. The diameter shall be identical to the pump nominal diameter, unless specific pressure drop calculations require otherwise. Use pipes with larger diameters to pump viscous fluids.

<p>Connect fixed pipes to the pump via a flexible hose in order to facilitate maintenance and avoid the transmission of mechanical loads to the pump. The pipes must be securely fastened down.</p>	
---	---

The pump has a slight pulse flow, with higher pulsations as rpm and pressure values are increased.

Adapt the brackets to your system to prevent the pulsations from causing damage to the pipelines or cause disturbance of downstream services.

The pump must be securely mounted to a fixed structure using the fixing holes in the skid.

Install the pump on anti-vibration mounts to reduce vibration.

**F.7 PIPES – CORRECT INSTALLATION**

**F.7.1 FLUID PRODUCTS**

Position the pump at the minimum possible distance from the suction tank (inlet)

Arrange the delivery pipeline (outlet) at an angle to facilitate discharge of the pumped fluid.

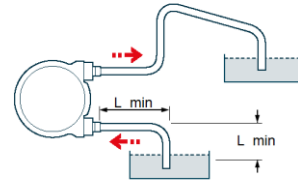

**F.7.2 VISCOUS PRODUCTS**

Set up the pump in flooded suction conditions.

We recommend fitting a safety device that trips in the event of tubular element rupture.

For pumping of corrosive or hazardous substances the pump should be installed in a spill containment berm.

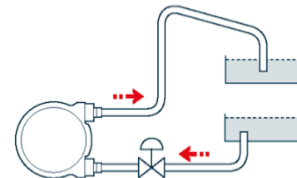

**F.7.3 OVERPRESSURE**

If the delivery pipe includes shut-off valves, install a pressure control system or a bypass line to protect the pump if the valves are inadvertently closed.

The same hazard may exist on the suction pipe in the event of pump reverse rotation.

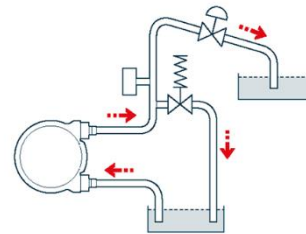

**F.7.4 PUMP STOPPED**

If the height of the delivery pipe is greater than 4 m, it may occur that the weight of the fluid in the pipe causes the pump roller to rotate in reverse, causing backflow towards the suction side.

This situation can be avoided by the use of brake motors, speed variators and check valves.

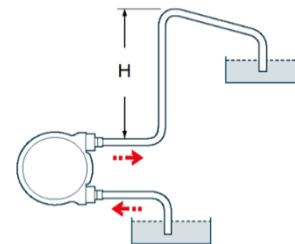

**G INSTRUCTIONS FOR COMMISSIONING - USE - SHUT-DOWNS**

**G.1 GENERAL WARNINGS FOR ROUTINE MACHINE OPERATION**

**The operator must:**

- Be trained and instructed as required by laws concerning safety in the workplace – legislative decree 81/2008 in Italy;
- Be in perfect mental and physical condition and be alert and with quick reflexes at all times;
- Use the personal protective equipment listed in the following heading (G.2);
- Before starting work with the machine, perform all the checks listed in the following heading to ensure that all the necessary safety conditions are present to prevent accidents.

**The operator must not:**

- Tamper with or alter the operation or efficiency of the protection devices installed on the machine.

**G.1.1 Checks and inspections for safe use of the machine**

**The operator must check:**

- That the machine has not been tampered with. if the machine has been tampered with remove it from service and notify the supervisor immediately;
- The general condition of the machine and its structures: must not be damaged or display conditions of evident negligence, especially in relation to ageing, wear and fatigue;
- That the machine bears all the icons and warning signs required, as shown in the chapter entitled “safe interaction with the machine”;
- That all the control devices are equipped with identification plates.



<p><b>WARNING:</b> If the machine is damaged or has been modified with respect to its original configuration as established by the manufacturer, it must not be used. Any technical alterations/modifications that affect machine operation or safety must be carried out exclusively by the manufacturer’s technical personnel or by technicians formally authorised by the manufacturer.</p>	
--	---

<p><b>WARNING:</b> The preliminary checks must be performed with the machine NOT connected to the electrical supply.</p>	
--	---



**G.2 PERSONAL PROTECTIVE EQUIPMENT**

The operator responsible for normal operation of the pump must use the following personal protective equipment:

Icon	Description	Notes
	FOOTWEAR	Use safety footwear to protect against the risk of falling objects.
	PROTECTIVE GLOVES	Safety gloves must be available for handling objects that could cause hand injuries.
	SUITABLE CLOTHING	Suitable clothing such as overalls. Do not wear clothing with loose sleeves and/or other loose items which could easily be drawn in by the mechanical parts of the machine.

<p><b>CAUTION:</b> Machine noise levels are below the noise emission limit established by law so the use of hearing protectors is not compulsory. However, the operator must consider the operating environment: if it is very noisy, hearing protectors must be worn. If earmuffs are used, the operator must take even greater care when using the machine due the contingent reduction in hearing sensitivity. Observe the surrounding environment carefully and use your eyes to compensate for your reduced hearing.</p>	
---	---

**G.3 EMERGENCY STOP**

If dangerous situations should occur during machine operation:

- For the operator;
- For any exposed persons;
- For the machine,

Stop the machine immediately by means of the red emergency stop pushbutton located on the main control panel.

<p><b>DANGER:</b> If the machine is not supplied in the configuration with electrical panel, it is the client's responsibility to equip it with an emergency stop pushbutton.</p>	
---	---

**G.3.1 Reset after an emergency stop**

Once the problem that made the emergency stop necessary has been resolved, proceed as follows:

- Restore the safety conditions needed to restart the machine;
- After checking for the absence of hazardous situations, the authorised operator can resume use of the machine;
- Reset the emergency stop pushbutton pressed by turning it in the direction indicated by the arrow on the button.

**G.4 START-UP**

Before starting the pump, make sure that:

- The tubular element used is appropriate for the fluid to be pumped.
- The mains voltage is compatible with the motor voltage and the electrical control panel voltage.

**MOVING PARTS HAZARD**

- Make sure the guards protecting moving parts are fitted.



- Check that the oil level in the gearbox is the one established (see paragraph L.3).
- Make sure the motor circuit breaker is calibrated in accordance with the motor rated values.
- Perform a short test to check the required direction of rotation;
- Check that any optional electrical components installed are correctly connected to the panel and test their efficiency.
- If delivery pressure is uncertain, e.g. because of high fluid viscosity, equip the delivery pipeline with a manometer.

**G.5 USE – START-UP (ROLLER IN WORKING POSITION)**

The pump is shipped with the roller in the **inoperative position** and is therefore not ready for use.

To set the roller to the **working position**:

- Turn the rotor and position it as shown in figure
- Disconnect the electrical supply;
- Unscrew nuts (1) and disassemble guide ring (2);

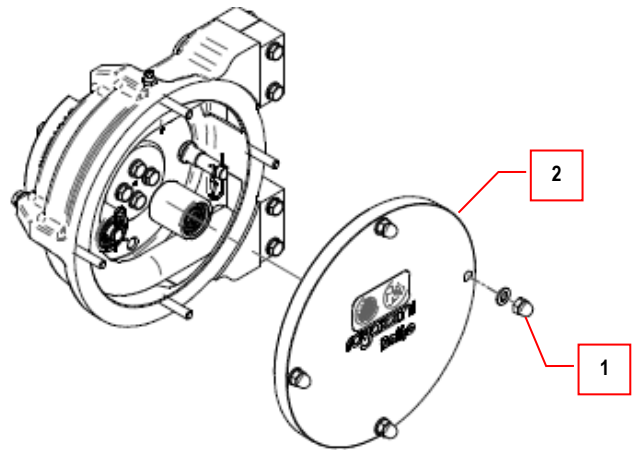

- Move the roller from the rest position (3) to the working position (4) and insert the roller retainer (5);
- Refit guide ring (2);
- Supply voltage;
- The pump is now ready for use.

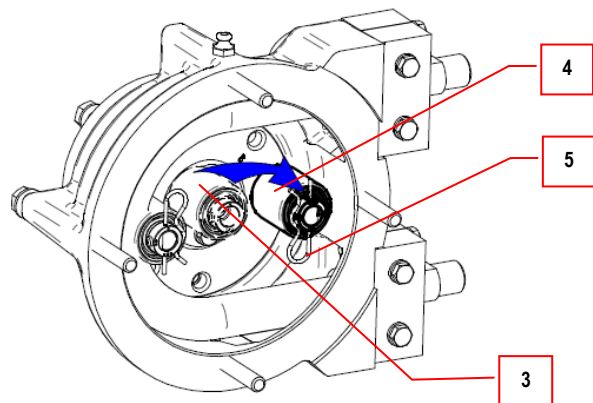

- Start the pump in the most favourable conditions: valves open and minimum speed, if adjustable.
- Perform some starts and stops and make sure that the controls properly work and that the system is liquid-tight.
- If the pump can be operated against closed valves, test the related safeties (pressure switch or bypass).
- Make sure the flow rate, pressure and motor power consumption values in the working conditions are in compliance with the design values.



**G.5.1 ACTIONS TO BE AVOIDED**

<p><b>WARNING:</b> Do not change the process fluid without cleaning the pump: mixing chemical products can be very dangerous.</p> <p>When the work process is terminated do not leave the pump full of product, especially in the case of corrosive fluids or fluids that may deposit residues, polymerize or with the risk of frost, or which may strain the mechanics at the next start, or attack the tubular element.</p> <p>In case of insufficient motor power, do not increase the protection settings in excess of the rated limits. Check system data and contact technical service if necessary.</p>	
--	---

<p><b>HAZARD:</b> When cleaning the pump with water jets, do not direct the jet on the motor or electrical equipment.</p> <p>Such non-compliance can cause danger of electrocution as well as damage to the electrical equipment itself.</p>	
--	---

**G.6 SHUT-DOWN**

**G.6.1 Stopping the pump**

The flow is stopped by stopping the motor. The pump functions as a shut-off valve because of the compression of the tubular element, except when the delivery height exceeds 4m, in which case the weight of fluid may cause the rollers to rotate in reverse resulting in the fluid returning to the suction pipe.

**G.6.2 Draining the pump**

Run the pump towards the drainage position on the pipelines by reversing the direction of rotation. Where there is a risk of frost, drain at the end of each work.

**G.6.3 Flushing the pipes**

Flush the pipelines and tubular element using fluids that are compatible with the tubular element material.

**G.6.4 Prolonged stops**

For prolonged stops:

- Perform drainage.
- Disconnect the plug or switch off the electricity.
- The roller must be in its inoperative position to avoid damage to the tubular element.
- Position the machine according to the instructions given in the paragraph E.5 STORAGE

**G.7 COMPLIANCE WITH HYGIENE REQUIREMENTS**

To satisfy the hygiene requirements (in case of pumping of food fluids) it is necessary to perform the following procedures.

**G.7.1 DRAINAGE**

To drain, see the paragraph G.6.2.

**G.7.2 CLEANING**

The pump must be cleaned:

- Before using the pump itself.
- At the end of the work cycle.
- At the end of each maintenance activity performed on the pump.

The pump must be cleaned using:

- Nitric acid 0,5% - max 50°C for 10 minutes,
- Acetic acid (not Peracetic) at 10% - max 50°C for 30 minutes
- Caustic soda at 15% - max 50°C for 20 minutes
- Rinse with cold water.

For PH type tubular element: hot water and neutral soap, rinse with distilled water. Can be sterilised in an AUTOCLAVE.

**G.8 RESIDUAL RISKS**

**G.8.1 Use with food fluids**

<p><b>WARNING:</b> Compliance of the pump for use with food fluids is retained as long as it is used with specifically designated food grade tubular elements (see instructions in paragraph N.3 <i>Tubular element selection guide</i>), with stainless steel fittings and adequate cleaning procedures (see the information in paragraph G.7 <i>Compliance with hygiene requirements</i>). Failure to comply with the above prescription results in hazards for food type applications.</p>	
---	---

<p><b>WARNING:</b> If the fluid is dangerous in terms of corrosion or fumes, take adequate precautions, namely:</p> <ul style="list-style-type: none"> <li>• Spill containment berm (in case of flooded suction and/or very long delivery pipelines)</li> <li>• Adequate air extraction or ventilation (for fluids that may release toxic or harmful fumes)</li> </ul>	
--	---

**Tubular element rupture sensor (optional):**

Rupture of the tubular element will cause leakage of fluid towards the well in which the safety float type leak detector is fitted; in this case the detector will trip to stop the pump and prevent external spills.

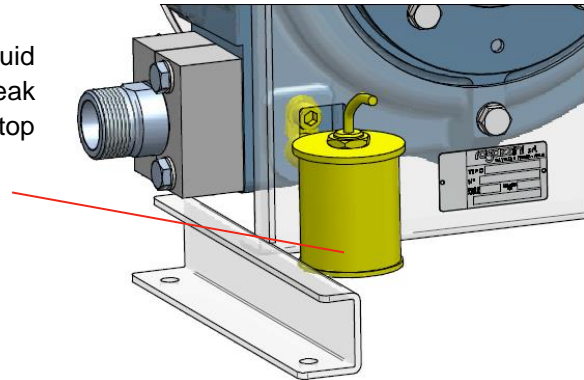

**G.9 PUMP CONFIGURATION - ROLLER SETTING**

The pump provides delivery pressure due to compression of the tubular element by rollers. The adjustment can be changed by acting on the combination of the roller pin position on the rotor and the position of the adjustment screw on the roller.

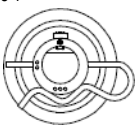
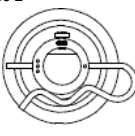
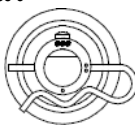
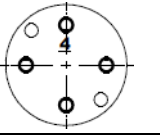
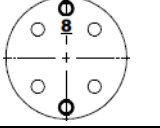
Roller	pos 1	pos 2	pos 3
Pin on rotor			
	<b>0</b>	<b>4</b>	<b>8</b>
	<b>4</b>	<b>8</b>	<b>12</b>

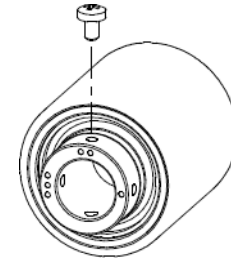

Adjustment screw on the roller

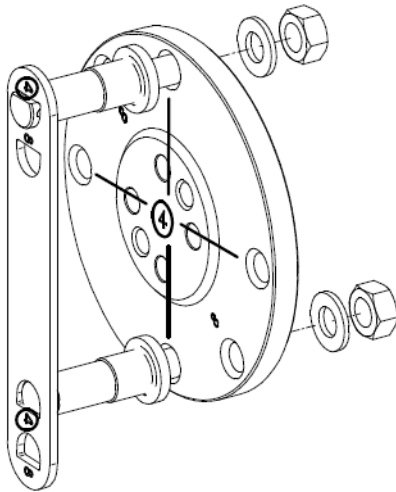

Mounting pin on the rotor with adjustment tool

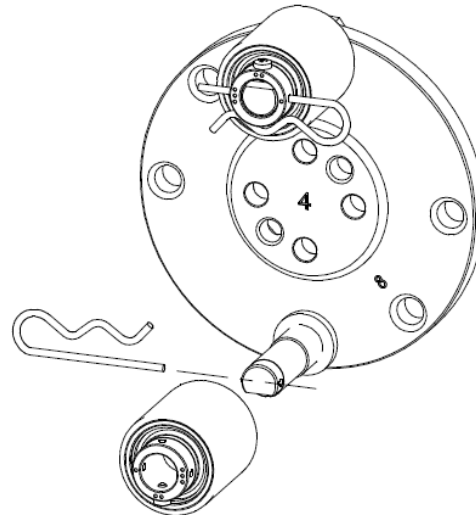

Roller positioning on a pin  
orient the springs as shown in the figure

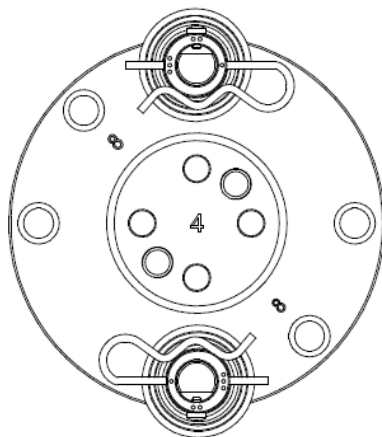

Complete assembly

The operating adjustment is established at the time of assembly of the pump and each subsequent change must be authorised by Ragazzini S.r.l. technical personnel.

**G.9.1 Setting with tubular element type "PHARMED®"**

Tubular element usage type "Pharmed®" involves the following changes:

- Assembly of n° 4 insert adapter (n° 2 for fitting).
- Configuration "8".
- Replace the standard rollers with "PH" type of increased diameter.

Pression of use: -0,5 ÷ 1,5 bar (2 bar peak)

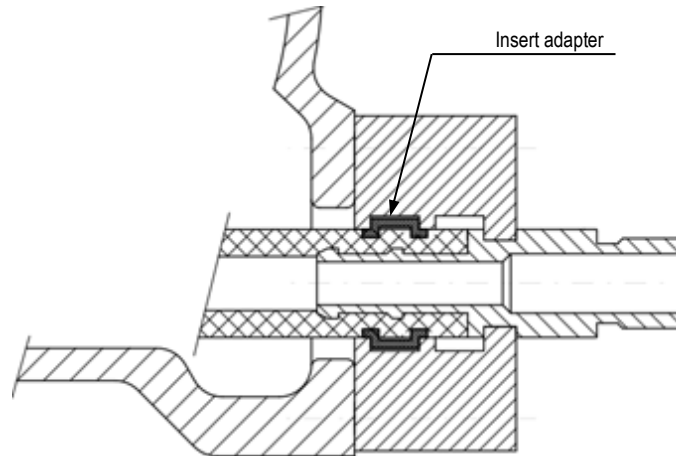

**H TROUBLESHOOTING**

PROBLEMS	CAUSE	SOLUTIONS
THE PUMP DOES NOT START OR STOPS	<ul style="list-style-type: none"> <li>• Power grid problem</li> <li>• Emergencies and / or safety devices intervened (see C.5.1 and C.5.2)</li> </ul>	<p>To verify:</p> <ul style="list-style-type: none"> <li>• Presence of voltage</li> <li>• Emergency stop pushbutton (see G.3)</li> <li>• Pressure switch (see L.5)</li> <li>• Motor thermal protection</li> </ul> <p>Note: before restoring, make sure that the conditions that caused the intervention have been resolved.</p>
PUMP DOES NOT PRIME	The pump has been idle for a prolonged period and the procedure recommended in F6 was not carried out beforehand	Leave pump running. After a short period it will prime correctly again. If the problem occurs when drawing fluid from an underground tank, prime the pump from an above ground tank
	The suction hose is crushed or clogged or it has a detached internal layer	In addition to meeting the requirements given in F6, the suction line must be equipped with a rigid fitting on the foot to guarantee complete opening
POOR EFFICIENCY	Air entering the suction line	Check pipe seals and possible pipe ruptures
	Excessively long suction pipeline	Comply with the indications given in F6 as far as possible
	High percentage of gas in the pumped liquid	Contact technical service
	Excessively worn tubular element	Perform periodic checks and replace the tubular element if necessary
VIBRATION OF PIPES	Insufficient air cushion in the pulsation dampeners	let it suck in air for a short time
	Restrictions in the suction pipeline	Comply with the indications given in F6 as far as possible Contact technical service
MOTOR OVERHEATING  CHECK THE POWER DRAW ON THE THREE PHASES AND COMPARE WITH THE MOTOR RATED VALUES.	The plant load is too high for the machine motor power	Contact technical service
	Electrical cables too long or insufficient conductor cross section	Contact an electrician
	Mains voltage drop or phase imbalance	Contact an electrician Consult the electricity supplier
	Insufficient ventilation	Check that the space around the motor is suitable for proper ventilation, free from dirt and foreign bodies. Check the fan.

PROBLEMS	CAUSE	SOLUTIONS
NOISE AND KNOCKING FROM INSIDE THE PUMP	Excessive suction head	Comply with the indications given in F6 as far as possible Contact technical service
	Restrictions in the pipes	
	Insufficient pipe diameter	

For any problems not appearing above, contact the Ragazzini S.r.l. technical assistance service.



## I MAINTENANCE

### I.1 GENERAL WARNINGS

<b>WARNING:</b> Maintenance technicians must carry out exclusively the maintenance operations described in this chapter. The supervisors and machine maintenance operators personnel must comply with the prescriptions issued by the Safety Authorities and must also perform all the operations listed in this chapter.	
---	---

<b>NOTE:</b> All the information on maintenance concerns solely and exclusively routine maintenance with interventions aimed at ensuring correct daily operation of the machine. If extraordinary maintenance operations are required, the specific point in the manual will instruct users to contact Ragazzini S.r.l., which will provide specific information.	
---	---

<b>WARNING:</b> Machine maintenance operations must be carried out in a non-explosive atmosphere.	
---	---

- The operations for machine set-up and adjustments are performed by one person only under the supervision of the maintenance supervisor.
- Untrained or unauthorised personnel must not enter the machine work area when maintenance is in progress.
- Maintenance operations must be carried out in adequate lighting conditions; in the case of maintenance work to be carried out in areas with insufficient lighting, use portable worklights, taking care to avoid areas of shadow that prevent or reduce visibility of the point in which the work must be performed and the surrounding areas.

### I.2 Precautions and warnings when preparing the machine for routine maintenance.

**The maintenance technician must:**

- Be aware that these operations may be associated with hazards.
- Comply with all the warnings shown on the machine, on the diagrams, in this document and in the attached documentation to avoid faults that in turn could directly or indirectly cause serious accidents, injury to persons or damage to property.
- Use the personal protective equipment described in the following paragraph.
- Avoid physical contact with moving parts of the machine.





The operator must also take into account the following:

<b>ELECTROCUTION HAZARD:</b> Maintenance operations that require the presence of electrical power, such as fault finding in the electrical panel, must be performed solely and exclusively by expert personnel following the safety procedures in force on the premises in which the machine is installed.	
--	---

<b>WARNING:</b> Any technical alterations/modifications that affect machine operation or safety must be carried out exclusively by the manufacturer's technical personnel or by technicians formally authorised by the manufacturer. Failure to observe this recommendation exonerates Ragazzini S.r.l. from all responsibility concerning the alterations or for any consequent damage. The guards and safety devices may be fully or partly removed during maintenance operations by expert and/or authorised personnel who must ensure that all removed safety devices/guards are duly refitted in their original position as soon as maintenance operations have been completed. The machine must not be started up after maintenance operations have been performed until the guards and other safety protections have been refitted.	
--	---

**I.3 PERSONAL PROTECTIVE EQUIPMENT**

The pump maintenance operator must use the following personal protective equipment:



Icon	Description	Notes
	FOOTWEAR	Use safety footwear to protect against the risk of falling objects.
	PROTECTIVE GLOVES	Safety gloves must be available for handling objects that could cause hand injuries.
	HARD HAT	A hard hat must be worn during machine lifting operations to protect against hazards generated by suspended loads.
	SUITABLE CLOTHING	Suitable clothing such as overalls. Do not wear clothing with loose sleeves and/or other loose items which could easily be drawn in by the mechanical parts of the machine.
	PROTECTIVE VISOR	Protective face shield when working on electrical parts, especially when live

<p><b>CAUTION:</b> Machine noise levels are below the noise emission limit established by law so the use of hearing protectors is not compulsory. However, the operator must consider the operating environment: if it is very noisy, hearing protectors must be worn. If earmuffs are used, the operator must take even greater care when using the machine due the contingent reduction in hearing sensitivity. Observe the surrounding environment carefully and use your eyes to compensate for your reduced hearing.</p>	
---	--

**I.4 PROCEDURES FOR PLACING THE MACHINE IN MAINTENANCE STATUS**

Proceed as follows:

- Complete the work cycle in progress.
- Stop the machine.
- Disconnect the electrical supply.
- Cordon off the machine and display a sign to the effect "MAINTENANCE IN PROGRESS" in a clearly visible position.

<p><b>WARNING:</b> Any maintenance work performed on the pump must be carried out with the machine stopped and disconnected from the electrical supply.</p>	 
---	--

<p><b>WARNING: NO ACCESS BY UNAUTHORISED PERSONS</b> Do not allow unauthorised persons to approach the machine when maintenance is in progress. Affix warning notices next to the disconnects to inform personnel that the machine is stopped for maintenance, in order to limit the risk of accidental and hazardous manoeuvres.</p>	
---	---

**I.5 NORMAL WEAR PARTS**

The only component subject to wear due to routine maintenance is the tubular element. It must therefore be replaced periodically.

**WARNING:**

Before opening the pump, make sure the pipeline is empty.  
The pressure exerted by the fluid on the tubular element could cause the rotor to turn, thus putting the operator at risk.



When there is a decrease in pump performance (wear index of this internal component), it must be checked.

**I.6 LUBRICATION**

The tubular element is already lubricated with silicone grease when it is initially installed.

Periodically, every 100 working hours, check that the stator wall supporting the tubular element is adequately lubricated. Inject a small amount of grease ~ 5 grams through the grease nipple.

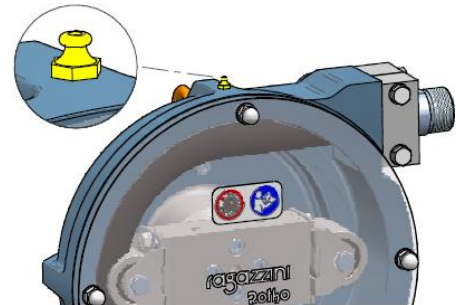

**CAUTION**

Use exclusively silicone grease **Rotho** Other greases will damage the tubular element.



**I.7 TUBULAR ELEMENT REPLACEMENT**

<p><b>WARNING:</b></p> <ul style="list-style-type: none"> <li>• Before opening the pump, make sure the pipeline is empty.</li> <li>• The pressure exerted by any fluid in the pipeline could cause the rotor to turn, thus putting the operator at risk.</li> </ul>	
---	---

- Turn the rotor until one of the rollers is no longer in contact with the tubular element (see figure).
- Disconnect the electrical supply.
- Dismantle the connection fittings on the suction and delivery pipes.
- Unscrew the nuts (1) and disassemble the external guide ring (2).

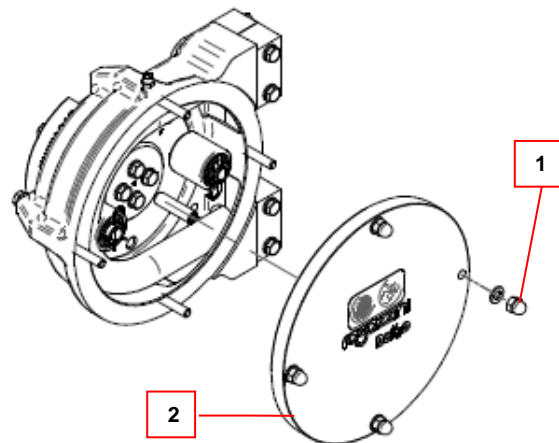

- Remove the roller retainer (3) and remove the roller (4) from its pin, positioning it as shown in the figure.

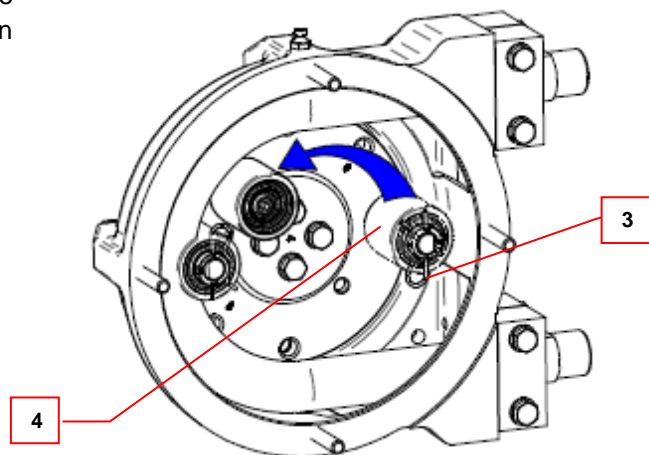

- Apply power momentarily to turn rotor until the roller is no longer in contact with the tubular element (see figure alongside).
- Disconnect power supply once again.
- Remove both the suction and the delivery fittings, taking care to possible seals.
- Open and disassemble the brackets (5) that fix the tubular element both on the suction side and on the delivery one.

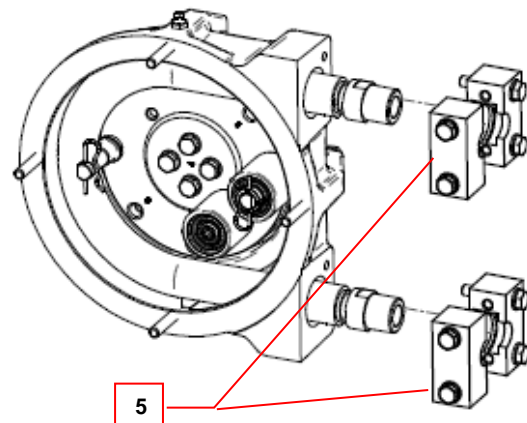

- Remove the fitting inserts (6) and remove the tubular element (7) from the stator.

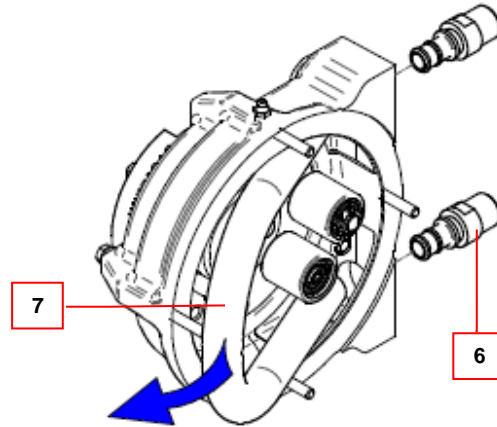

- Lubricate the contact area of the new tubular element and assemble it on the stator by performing the above steps in reverse sequence.

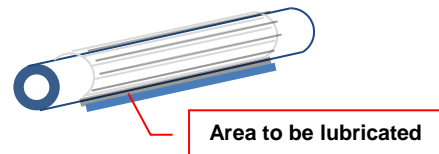

**I.8 TUBULAR ELEMENT RUPTURE SENSOR (OPTIONAL)**

This is a safety system comprising a float sensor that trips to stop the pump if the tubular element ruptures resulting in internal leakage of the fluid.

The sensor must be connected to an electrical panel as per the diagram given below in point I.8.2.

This device is maintenance free, but a check should be performed periodically to ensure the float is free moving.

The sensor is fixed to cover (3).

The unit can be emptied of liquid by removing plug (2) located under support (1).

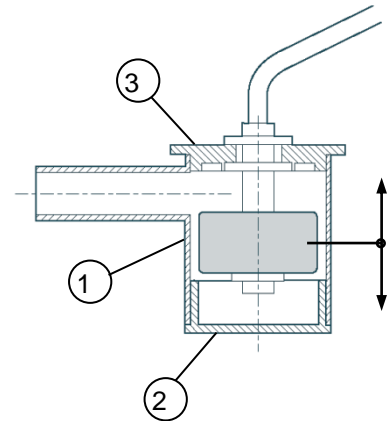

**I.8.1 Technical data**

<b>Minimum specific weight detectable</b>	0.65 kg /l
<b>Output function</b>	NC
	NO by overturning the float
<b>Contact ratings</b>	250 V; 2.5 A; 100 VA
<b>Tank</b>	non-toxic polypropylene
<b>Protection rating (EN 60-259-)</b>	IP 68
<b>Working temperature</b>	-25 ... +100°C
<b>Electrical output cable</b>	silicone AWG20

**I.8.2 Electrical connections (typical wiring diagram)**

Tripping of the sensor causes the machine to stop. The system can be restarted only with an operator command.

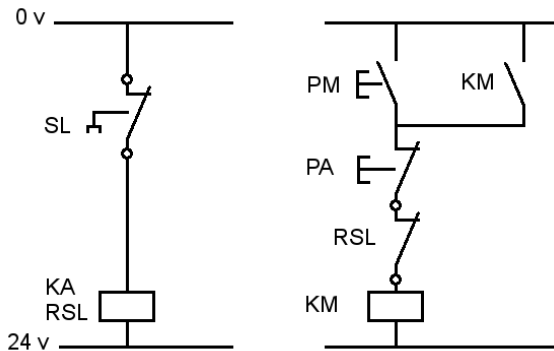

SL	level sensor
KA	auxiliary circuits relay coil
RSL	auxiliary circuits relay contact
KM	contactor coil
PM	start button
PA	stop button

**I.8.3 ATEX version**

Refer to the documentation in the documents folder attached to the machine.



**I.9 PROLONGED DISUSE**

If the machine remains out of use for more than one month, in order to extend the life of the tubular element it must not remain be compressed by the roller to no effect.

For this purpose, the roller must be set to its inoperative position:

- Turn the rotor until one of the rollers is no longer in contact with the tubular element;
- Disconnect the electrical supply;
- Unscrew nuts (1) and remove guide ring (2);
- Remove the roller retainer (3) and remove the roller (4) from its pin; put it as shown in the figure;
- Refit the guide ring;
- Reconnect the power supply;
- Turn the rotor until the roller is no longer in contact with the tubular element.

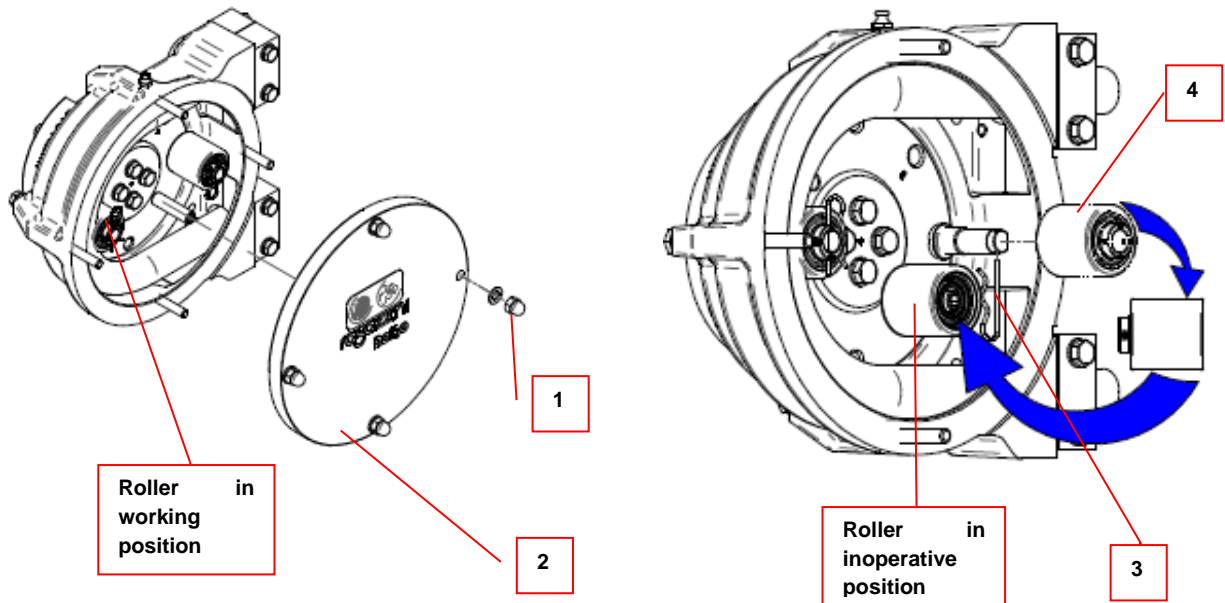

**I.10 COMPONENTS MAINTENANCE – PSF PUMP ATEX VERSION**

**DANGER:** Maintenance procedures must be performed in the absence of potentially explosive atmospheres.



A periodic cleaning plan must be drawn up to avoid the potentially hazardous accumulation of dust on the casing, which generates dangerous layers greater than 1 mm.

The bearings of the rollers and the rotor must be renewed every 20000 hours of operation or at the minimum sign of damage. The lubricant used must have an ignition temperature of 50 K above the maximum surface temperature of the pump, indicated on the plate. For details of the specific procedure, consult the Ragazzini S.r.l. engineering department.

It is mandatory to re-paint any external metal parts of the equipment that have lost their protective paint coating through time. Use paint containing less than 25% by weight of aluminium with a maximum dry film thickness of 0,2 mm.

- If the level sensor (ATEX certified for gas and dust in category 1 or 2) is to be replaced, a new sensor having the same characteristics must be installed.
- If the pressure switch (ATEX certified for gas and dust in category 1 or 2) is to be replaced, a new pressure switch having the same characteristics must be installed.
- If the electrical panel (ATEX certified for gas and dust in category 1 or 2) is to be replaced, a new electrical panel having the same characteristics must be installed.
- If the gear unit (ATEX certified for gas and dust in category 1 or 2) is to be replaced, a new gear unit having the same characteristics must be installed.
- If the variator (ATEX certified for gas and dust in category 1 or 2) is to be replaced, a new variator having the same characteristics must be installed.
- If the electric motor (ATEX certified for gas and dust in category 1 or 2) is to be replaced, a new motor having the same characteristics must be installed.
- If the suction hose is to be replaced, use exclusively Ragazzini S.r.l. original replacement parts. These components guarantee resistivity values below 1GΩ.
- If the wheels must be replaced (ATEX certified in category 1 or 2), new wheels with the same characteristics must be installed.



**J SPARE PARTS**

**J.1 HOW TO ORDER SPARE PARTS**

To avoid misunderstandings and/or shipment of parts that are unsuitable for the intended purpose, include the following identification data when requesting original replacement parts:

- Pump model.
- Pump serial number.
- Article code.
- Article description.
- Quantity.
- Type of shipment required.

The identification dataplate shown here is affixed to the pump.

The information on the dataplate is necessary for identification of the pump.

- A. Pump model.
- B. Serial number.
- C. CE conformity mark (present only when the pump is supplied with motor and control panel).



**J.2 EXAMPLE ORDER**

Pump model: PSF\_

Pump serial number: XXXXXX

Code	Description	Quantity
A204_ _ _ _ _	ROTHO ROLLER _ _ _	N° 1
A203_ _ _ _ _	INSERT _ _ _	N° 1

Type of shipment required: Shipping agent: YYYYYY

**J.3 SPARE PARTS LIST**

**HAZARD:** For pump spare parts in ATEX version refer to paragraph I.10 "COMPONENTS MAINTENANCE – PSF PUMP ATEX VERSION".



The use of the pump is of fundamental importance for determining the construction material of the components. The optimal choice depends on several factors: chemical compatibility, working temperature, compatibility with food, fluid to be pumped and operating pressure. The following components are subject to variation depending on the application, contact the Technical Service **ragazzini** s.r.l.:

- Tubular Element (see paragraph N.3)
- Inserts
- Dampeners and connection fittings (see paragraph L).

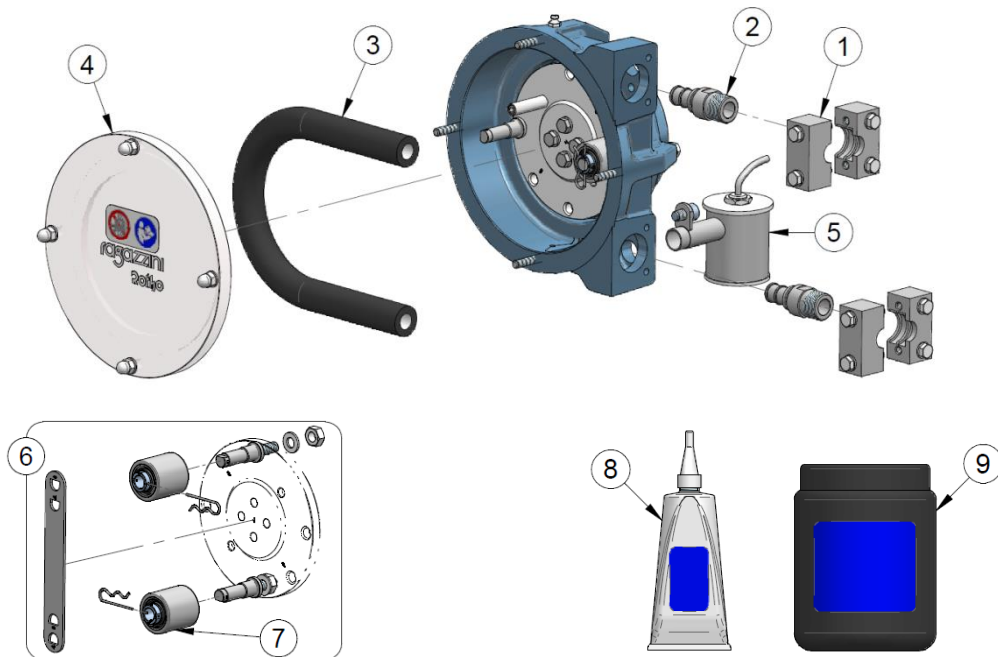

Pos.	Description	ATEX		N.	Code
1	PSF2 BRACKET		✓	2	A5010694A
2	PSF2 INSERT 3/4" BSP- 316 (**)		✓	2	A2031752A (**)
3	PSF2 TUBULAR ELEMENT (*)		✓	1	(*)
4	PLEXI GUIDE PSF2 "RAG"		✓	1	A3002151A
5	+ MS1-2-3 PSF1-2 LEAK DETECTOR (OPTIONAL)	x		1	W05105810
6	+ PSF2 ROLLER 2RS KIT		✓	1	W06025020
7	PSF2 ROLLER 2RS (**)		✓	2	A2042509A (**)
8	SILICON GREASE -tube		✓	1	OB0010010
9	SILICON GREASE -pack		✓	1	OB0010003

(\*) See: "CHARACTERISTIC DATA - MACHINE CONFIGURATION" for the TYPE and PART NUMBER of the installed tubular element.

(\*\*) Alternative:

Pos.	Description	ATEX		N.	Code
2	PSF2 INSERT 3/4" BSP- PP	x		2	A2031743A
2	PSF2 INSERT 3/4" BSP- PVC	x		2	A2031742A
2	PSF2 INSERT 3/4" NPT- 316		✓	2	A2032108A
2	PSF2 INSERT 3/4" NPT- PVC	x		2	A2032107A
2	PSF2 INSERT 3/4" NPT- TIT		✓	2	A2032109A
2	PSF2 INSERT CLAMP 3/4"- 316		✓	2	A2032515A
2	PSF2 INSERT DIN 15 F- 316		✓	2	A2032518A
7	PSF2 ROLLER 2RS -PH-		✓	2	A2042512A

For parts that do not appear in the list, contact **ragazzini** s.r.l.

**K SCRAPPING AND DISPOSAL**

**K.1 GENERAL WARNINGS CONCERNING SCRAPPING AND DISPOSAL OF THE MACHINE**

**WARNING:** Machine scrapping operations must be carried out in a non-explosive atmosphere. 





**K.1.1 Special and hazardous waste**

- Special waste means residues deriving from industrial processes, materials from scrapped machines or deteriorated and obsolete equipment.
- Hazardous waste is waste generated by production activities and containing a significant quantity of pollutants.

**WARNING:** Disposal of special waste and hazardous waste must be carried out in compliance with statutory legislation. For Italy comply with Legislative Decree 3/4/2006 n. 152, modified by Legislative Decree 3/12/2010, no. 205 and subsequent amendments and additions (“Provisions implementing directive 2008/98/EC”). 

**K.2 PERSONAL PROTECTIVE EQUIPMENT REQUIRED DURING MACHINE SCRAPPING AND DISPOSAL**

The operator responsible for scrapping and disposal operations must use the following personal protective equipment:

Icon	Description	Notes
	FOOTWEAR	Use safety footwear to protect against the risk of falling objects.
	PROTECTIVE GLOVES	Safety gloves must be available for handling objects that could cause hand injuries.
	HARD HAT	A hard hat must be worn during machine lifting operations to protect against hazards generated by suspended loads.
	SUITABLE CLOTHING	Suitable clothing such as overalls. Do not wear clothing with loose sleeves and/or other loose items which could easily be drawn in by the mechanical parts of the machine.

**K.3 DISMANTLING THE MACHINE**

The qualified and authorised operator responsible for dismantling the machine must:

- Use the P.P.E. shown in the above heading (K.2) for all the required procedures.
- Create sufficient space around the machine to perform all movements without risks for persons.
- Open the machine energy supply isolating devices and lock them out in the OFF position.
- Disconnect the power feeding cable from the isolating device, disconnecting first the power conductors and then the protective earth conductor.
- Only after performing all the above activities, proceed to dismantle the machine, working from top down and paying special attention to machine parts/units that may fall when freed and all components that may contain product residues.

#### K.4 SORTING MATERIALS

After dismantling the machine in accordance with the above procedure, the various materials must be sorted by type:

- Remove the various machine parts from the work area, taking all the necessary precautions.
- Before lifting very large parts, check that the lifting devices are correctly secured and use exclusively adequate harnesses and lifting tackle.
- Sort the various components by type, as far as possible. The parts should be sorted according to material type (plastic, metal, etc.) and then discarded through sorted waste collection channels. The parts resulting from scrapping of the machine should be consigned to an authorised sorted waste disposal agency.

**DANGER - SUSPENDED LOADS:**

Pay the utmost attention when lifting parts of the machine during scrapping operations.



#### K.5 DISPOSING OF MACHINE MATERIALS AND PRODUCTS

The machine is made of non-hazardous materials, primarily stainless steel, iron, aluminium, cast iron, copper, plastic and rubber.

In particular, the body of models PSF 1, 2 and 3 is made of aluminium or cast iron with steel interior.

These materials are not subject to degradation such as to constitute a risk for operators.

All electrical and electronic components are commercial parts sourced by Ragazzini s.r.l. and have already been certified in compliance with Directive 2011/65/EU (RoHS) by their manufacturers.

The materials used to protect the machine during transport must be recycled or discarded in compliance with statutory legislation in the destination country.



Pay attention to the recycling symbol:

Disposal must be entrusted to specialised collection agencies.

**L PUMP OPTIONAL CONFIGURATIONS**

Optional configurations and accessories available for the PSF series peristaltic pump are as follows:

- Fixed pump with skid;
- Pump without driveline components;
- Pump complete with gear unit, electric motor and electrical panel;
- Pump complete with gear unit and electric motor;
- Transportable trolley-mounted pump;
- Stainless steel compensators mounted on the connection fittings;
- Compensators flushing kit;
- PVC connection fittings;
- PVC compensators for assembly in line;
- Differential pressure switch;
- Stainless steel fittings with process connections:  
with ANSI or UNI flanges, BSP, NPT, DIN threads or Tri CLAMPs.

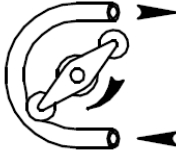
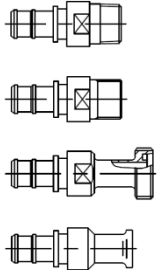
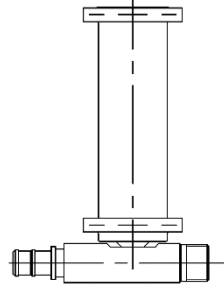
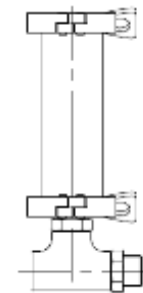
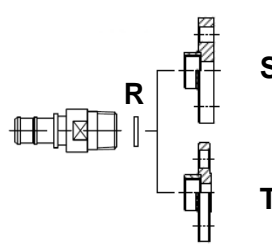
<p>DISCHARGE</p>  <p>SUCTION</p>	 <p>BSP NPT DIN 11851 CLAMP</p> <p>DISCHARGE / SUCTION</p>	<p>A)</p>  <p>DAMPENER ONLY DISCHARGE</p>	<p>B)</p>  <p>DAMPENER ONLY DISCHARGE</p>	
<p>MODEL</p>	<p>FITTINGS</p>	 <p>R S T</p>		
<p><b>PSF2</b></p>	<p>3/4" BSP 316</p>			<p><b>R</b> Fiber washer d16.24.1.8</p>
	<p>3/4" BSP PVC</p>			<p><b>S</b> EN 1092-1 PN 16 3/4" F / Dn 15</p>
	<p>3/4" NPT 316</p>			<p><b>T</b> ANSI 150 lb 3/4" F / ANSI 1/2"</p>
	<p>3/4" NPT PVC</p>			
	<p>DIN 15 F 316</p>			
	<p>CLAMP 3/4" 316</p>			

**L.1 CONFIGURATION WITH ELECTRICAL PANEL**

The electrical panel and manual controls must be installed at a height and position such as to allow the operator ready access during use without having to stretch or assume awkward postures.

The panel and manual controls must be installed outside the danger zones.

Refer to technical standards EN60204-1 and EN894-4 for useful recommendations concerning the above requirements.

Refer to the annexed documentation for a description of the controls.

**L.1.1 ATEX version**

Refer to the documentation in the documents folder attached to the machine.



**L.2 TROLLEY-MOUNTED CONFIGURATION**

For greater manoeuvrability of the pump, 2 pivoting wheels with brake and 2 fixed wheels can be installed on the frame.

**L.2.1 ATEX version**

The skid will be fitted with antistatic wheels.

Refer to the documentation in the documents folder attached to the machine.



**L.3 GEAR UNIT**

The pump may be supplied with or without a gear unit.

The gear units are life lubricated and do not normally require lubricant top-ups or changes for their full working life. If the lubricant must be changed following repairs, comply with the procedure described on the installed gear unit manufacturer's website.



Worm gear unit

**L.3.1 ATEX version**

Refer to the documentation in the documents folder attached to the machine.



**L.4 MOTOR**

The pump can be supplied with or without a prime mover (electric motor or other types).

For routine and extraordinary maintenance of the motor, comply with the procedures described on the installed motor manufacturer's website.



**L.4.1 ATEX version**

Refer to the documentation in the documents folder attached to the machine.



**L.5 PRESSURE SWITCH**

Differential pressure switch for line pressure control.

**L.5.1 Technical data**

<b>Adjustment range:</b>	0.5 ... 8 bar (1)
<b>Differential trip:</b>	0.3 ... 5 bar (2)
<b>Sensitivity threshold:</b>	0.2 bar (3)
<b>Max permissible pressure:</b>	30 bar
<b>Contact ratings:</b>	24 V; 6 A
<b>Protection rating -EN 60 529-:</b>	IP 54
<b>Ambient temperature:</b>	- 20 + 70°C
<b>Fluid working temperature:</b>	+70°C max.

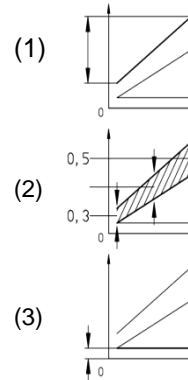

**L.5.2 Electrical connections**

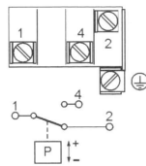

Differential type pressure switch; exchanges the contact at maximum pressure and releases it at reset pressure.

The pressure switch can operate with the following operating logic depending on the pump model and the electrical panel installed:

- **“Automatic”**: the pump stops when the upper pressure limit is exceeded and restarts automatically when the pressure falls below the reset value
- **“Safety”**: the pump stops when the upper pressure limit is exceeded and restarts only and exclusively after the consent of the operator and with pressure below the reset value.

**L.5.3 Calibration**

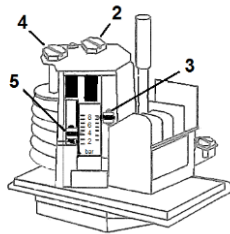

With the calibration screw 2 the upper intervention point is adjusted. Indication with index 3 (red arrow).

With the calibration screw 4 the lower intervention point is adjusted; the upper point remains unchanged. Indication with index 5 (green arrow).

The adjustment scale is not calibrated. For a more precise calibration use a pressure gauge.

Note: the green arrow 5 must never be below the minimum value of the scale.

**L.5.4 Overall dimensions**

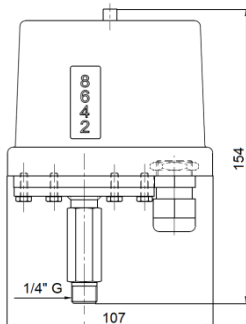

**L.5.5 ATEX version**

Refer to the documentation in the documents folder attached to the machine.





**M IDEAL CHARACTERISTIC EFFICIENCY OF THE PERISTALTIC PUMP**

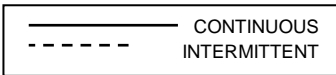
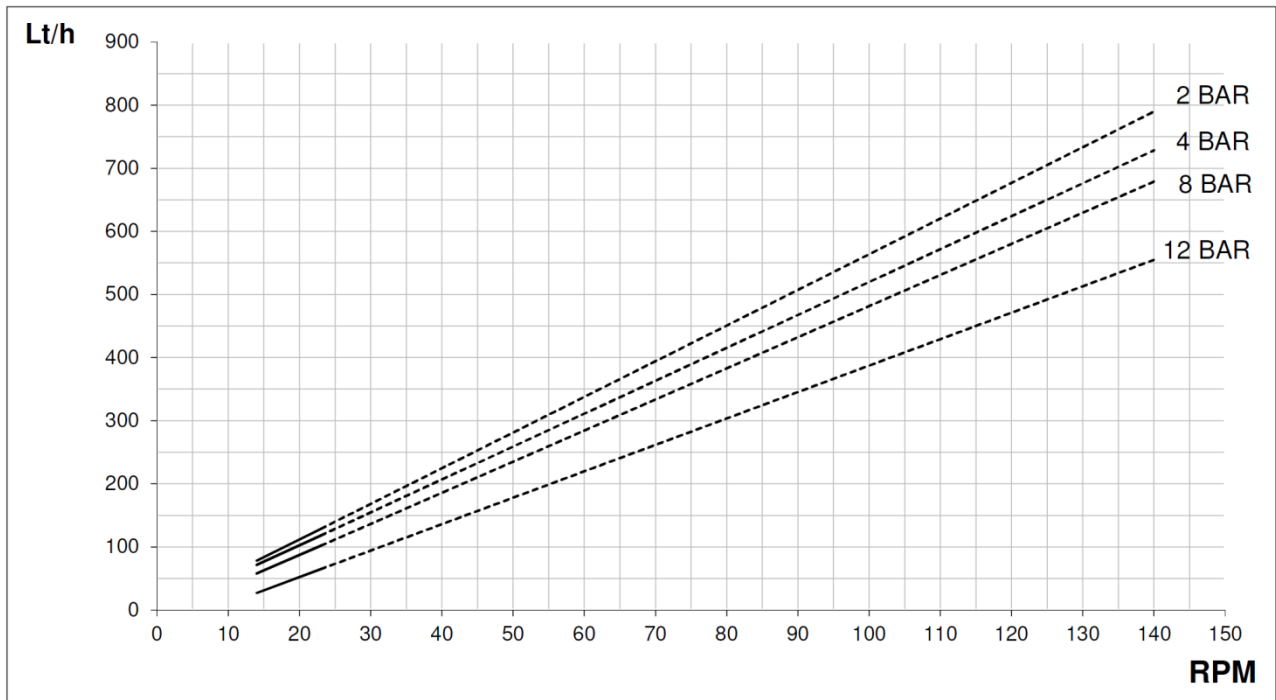

l/h FLOW RATE  
Q% FLOW RATE %  
H SUCTION HEAD (meters of water column)  
RPM ROTOR REVOLUTIONS PER MINUTE

These characteristic curves were plotted by pumping pure water (low dissolved gases) at 20°C, pressure of 1 atm, with a small suction head and hoses of identical diameter to the diameter of the pump connections

Different types of fluids can produce major variations:

- Heavy fluids, i.e. with specific density greater than 1
- Viscous fluids
- Hot fluids
- Fluids with high contents of dissolved gases

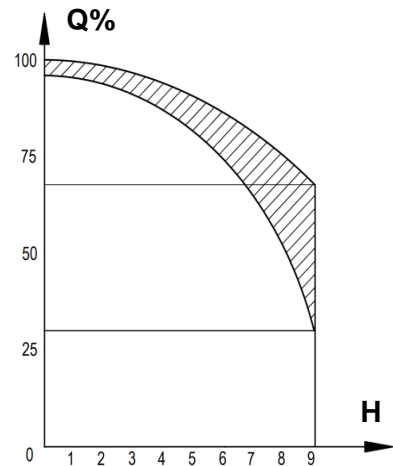

## **N TUBULAR ELEMENT**

### **N.1 SELECTION CRITERIA**

The tubular element type characterises the use and limits of the peristaltic pump.

The optimal choice depends on several factors:

- Chemical compatibility;
- Working pressure;
- Working temperature;
- Pump rpm;
- Suction capacity;
- Service factor;
- Required durability;
- Food grade compatibility.

Request information on use directly from **ragazzini** at the time of the order.  
For fluids or conditions not listed here, take the following precautions:

<ul style="list-style-type: none"> <li>• <b>CHEMICALS HAZARD:</b> Take account of the hazards implicit in handling aggressive chemicals (possible liquid spills). Special conditions of temperature, pressure and concentration affect the degree of aggressiveness of products and may make it dangerous to use the pump.</li> </ul>	
---	---

- Perform an immersion test. Cut a specimen segment of hose and measure the weight, length and other physical parameters. Immerse the test piece in the process liquid for approximately 72 hours and take note of any changes in colour, dimensions, weight, hardness or any other damage. At this point, perform a trail run with the pump.

### **N.2 DISPOSAL**

Comply with local waste disposal regulations.

Contact the competent local office and specify if the product has come into contact with dangerous, toxic or harmful fluids.

The material of the tubular element is vulcanized rubber and synthetic textile inserts.

N.3 TUBULAR ELEMENT SELECTION GUIDE

Hose colour	BLUE	RED	GREEN	YELLOW	WHITE	ORANGE	BEIGE
Hose code	<b>NN</b>	<b>NP</b>	<b>EP</b>	<b>RN</b>	<b>RF</b>	<b>HY</b>	<b>PH</b>
Composition	Natural Rubber	Substrate for food products Natural Rubber	Ethyl Propylene Monomer <b>EPDM</b>	Substrate in Nitrile-Butadiene <b>NBR</b>	Substrate for food products Nitrile-Butadiene <b>NBR</b>	Chlorosulfonated Polyethylene <b>HYPALON</b>	Elastomer based thermoplastic polypropylene <b>PHARMED</b>
Physical characteristics	Multi-layer tube with reinforcing textile inserts						
TEMP. °C	-10 +85	-10 +75	-10 +95	-10 +75	-10 +75	-10 +85	-20 +135
PRESS. BAR	-0.9 +8 (15)	-0.9 +6(8)	-0.9 +8	-0.9 +6(8)	-0.9 +6(8)	-0.9 +8	-0.5 +1.5/2
Compatibility	Excellent for abrasive liquids, moderately aggressive liquids and high pressure fluids	Similar to NN, can be used for food products	Suitable for chemical uses and for high pressures	Suitable for oils, fats, hydrocarbons and miscellaneous solvents	Suitable for food oils and fats	Suitable for concentrated acids and alkaline liquids.	Suitable for liquid pharmaceutical and food products.
Mechanical characteristics Resistance/Lifetime	HIGH	HIGH	MEDIUM	MEDIUM	HIGH	HIGH	HIGH
Food Classification		A), B)			C)		C)
For cleaning: C.I.P. and S.I.P. we recommend removing the roller		Sanitizable with: Nitric acid 0.5% max 50°C for 10 minutes, or Acetic Acid (not Peracetic) at 10% max 50°C for 30 minutes, or Caustic soda at 15% max 50°C for 20 minutes. Rinse with cold water.  Wash with steam at 120° open ends. 3 minutes max			Sanitizable with: Nitric acid 0.5% max 50°C for 10 minutes, or Acetic Acid (not Peracetic) at 10% max 50°C for 30 minutes, or Caustic soda at 15% max 50°C for 20 minutes. Rinse with cold water.  Wash with steam at 120° open ends. 3 minutes max		Sanitizable with hot water and neutral soap. Rinse with distilled water.  Can be sterilised in an AUTOCLAVE

A) Reg. EC 1935/2004 and subsequent modifications and additions  
Reg. EC 2023/2006 and subsequent modifications and additions

D.M. 21/03/1973 and s.m.a. for aqueous, acidic, alcoholic food products up to 50% v/v, up to 70°C.

B) FDA-CFR 21 Parts 170 to 199 Item 177.2600 paragraphs (a), (b), (c), (d), (e) for contact with aqueous foods.

C) Different certifications available according to the pump model. Request a fac-simile.

